

# VS-10

*Home Theater Sound System*  
*Système audio home cinéma*

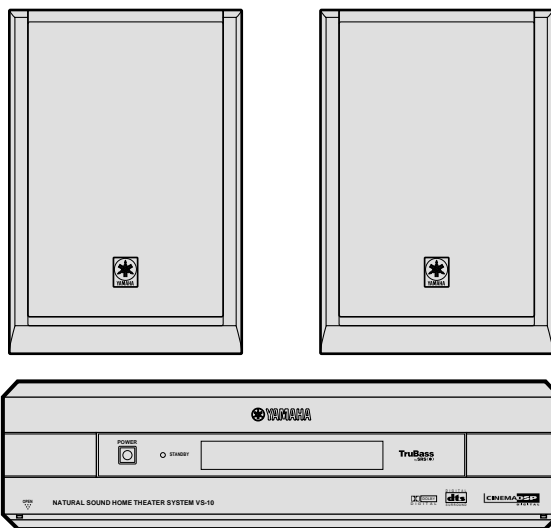

OWNER'S MANUAL  
MODE D'EMPLOI  
MANUAL DE INSTRUCCIONES

# IMPORTANT SAFETY INSTRUCTIONS

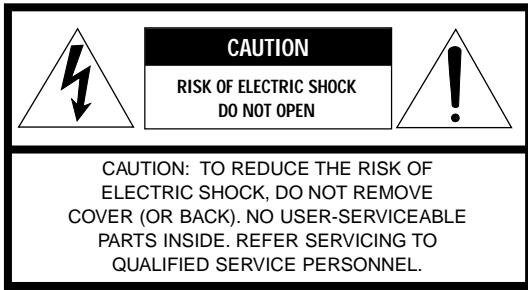

- Explanation of Graphical Symbols

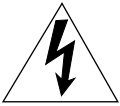

The lightning flash with arrowhead symbol, within an equilateral triangle, is intended to alert you to the presence of uninsulated "dangerous voltage" within the product's enclosure that may be of sufficient magnitude to constitute a risk of electric shock to persons.



The exclamation point within an equilateral triangle is intended to alert you to the presence of important operating and maintenance (servicing) instructions in the literature accompanying the appliance.

**WARNING**  
TO REDUCE THE RISK OF FIRE OR ELECTRIC SHOCK, DO NOT EXPOSE THIS UNIT TO RAIN OR MOISTURE.

- 1 Read these instructions.
- 2 Keep these instructions.
- 3 Heed all warnings.
- 4 Follow all instructions.
- 5 Do not use this apparatus near water.
- 6 Clean only with dry cloth.
- 7 Do not block any ventilation openings. Install in accordance with the manufacturer's instructions.
- 8 Do not install near any heat sources such as radiators, heat registers, stoves, or other apparatus (including amplifiers) that produce heat.
- 9 Do not defeat the safety purpose of the polarized or grounding-type plug. A polarized plug has two blades with one wider than the other. A grounding type plug has two blades and a third grounding prong. The wide blade or the third prong are provided for your safety. If the provided plug does not fit into your outlet, consult an electrician for replacement of the obsolete outlet.
- 10 Protect the power cord from being walked on or pinched particularly at plugs, convenience receptacles, and the point where they exit from the apparatus.
- 11 Only use attachments/accessories specified by the manufacturer.
- 12 Use only with the cart, stand, tripod, bracket, or table specified by the manufacturer, or sold with the apparatus. When a cart is used, use caution when moving the cart/apparatus combination to avoid injury from tip-over. 
- 13 Unplug this apparatus during lightning storms or when unused for long periods of time.
- 14 Refer all servicing to qualified service personnel. Servicing is required when the apparatus has been damaged in any way, such as power-supply cord or plug is damaged, liquid has been spilled or objects have fallen into the apparatus, the apparatus has been exposed to rain or moisture, does not operate normally, or has been dropped.

## FCC INFORMATION (for US customers only)

**1. IMPORTANT NOTICE : DO NOT MODIFY THIS UNIT!**

This product, when installed as indicated in the instructions contained in this manual, meets FCC requirements. Modifications not expressly approved by Yamaha may void your authority, granted by the FCC, to use the product.

**2. IMPORTANT :** When connecting this product to accessories and/or another product use only high quality shielded cables. Cable/s supplied with this product **MUST** be used. Follow all installation instructions. Failure to follow instructions could void your FCC authorization to use this product in the USA.

**3. NOTE :** This product has been tested and found to comply with the requirements listed in FCC Regulations, Part 15 for Class "B" digital devices. Compliance with these requirements provides a reasonable level of assurance that your use of this product in a residential environment will not result in harmful interference with other electronic devices.

This equipment generates/uses radio frequencies and, if not installed and used according to the instructions found in the users manual, may cause interference harmful to the operation of other electronic devices.

Compliance with FCC regulations does not guarantee that interference will not occur in all installations. If this product is found to be the source of interference, which can be determined by turning the unit "OFF" and "ON", please try to eliminate the problem by using one of the following measures:

Relocate either this product or the device that is being affected by the interference.

Utilize power outlets that are on different branch (circuit breaker or fuse) circuits or install AC line filter/s.

In the case of radio or TV interference, relocate/reorient the antenna. If the antenna lead-in is 300 ohm ribbon lead, change the lead-in to coaxial type cable.

If these corrective measures do not produce satisfactory results, please contact the local retailer authorized to distribute this type of product. If you can not locate the appropriate retailer, please contact Yamaha Electronics Corp., U.S.A. 6660 Orangethorpe Ave, Buena Park, CA 90620.

The above statements apply **ONLY** to those products distributed by Yamaha Corporation of America or its subsidiaries.

## We Want You Listening For A Lifetime

YAMAHA and the Electronic Industries Association's Consumer Electronics Group want you to get the most out of your equipment by playing it at a safe level. One that lets the sound come through loud and clear without annoying blaring or distortion – and, most importantly, without affecting your sensitive hearing.

Since hearing damage from loud sounds is often undetectable until it is too late, YAMAHA and the Electronic Industries Association's Consumer Electronics Group recommend you to avoid prolonged exposure from excessive volume levels.



**IMPORTANT**

Please record the serial number of this unit in the space below.

**MODEL:**

Serial No.:

The serial number is located on the rear of the unit. Retain this Owner's Manual in a safe place for future reference.

**WARNING**

TO REDUCE THE RISK OF FIRE OR ELECTRIC SHOCK, DO NOT EXPOSE THIS UNIT TO RAIN OR MOISTURE.

# CAUTION: READ THIS BEFORE OPERATING YOUR UNIT.

- 1 To assure the finest performance, please read this manual carefully. Keep it in a safe place for future reference.
- 2 Install this unit in a well ventilated, cool, dry, and clean place with at least 10 cm above, behind and on the both sides of this unit - away from direct sunlight, heat sources, vibration, dust, moisture, and/or cold.
- 3 Position this unit away from other electrical appliances, motors and transformers to avoid humming sounds, do not place this unit where it may get exposed to rain or any kind of liquid to prevent fire or electrical shock.
- 4 Avoid extreme temperature swings or excessive use of humidifier in the room where this unit is installed to prevent condensation inside this unit, which may cause an electrical shock, fire damage to this unit, and/or personal injury.
- 5 Do not cover this unit with a newspaper, a tablecloth, a curtain, etc. in order not to obstruct heat radiation. If the temperature inside this unit rises, it may cause fire, damage to this unit and/or personal injury.
- 6 Avoid installing this unit in a place where foreign objects and liquid might fall. It might cause a fire, damage to this unit and/or personal injury. Do not place the following objects on this unit:
  - Other components, as they may cause damage and/or discoloration on the surface of this unit.
  - Burning objects (i.e., candles), as they may cause fire, damage to this unit and/or personal injury.
  - Containers with liquid in them, as they may cause an electrical shock to the user and/or damage to this unit.
- 7 Do not operate this unit upside-down. It may overheat, possibly causing damage.
- 8 When moving this unit, be sure to first disconnect the power cord from the AC outlet and disconnect all cords connecting this unit to other equipment.
- 9 Do not use force on switches, controls or connection cables. Never pull the cables when disconnecting them.
- 10 Only voltage specified on this unit must be used. Using this unit with a higher voltage than specified is dangerous and may result in fire or other accidents. YAMAHA will not be held responsible for any damage resulting from the use of this unit with a voltage other than that specified.
- 11 Do not attempt to clean this unit with chemical solvents; this might damage the finish. Use a clean, dry cloth.
- 12 Disconnect the power cord from the wall outlet when not planning to use this unit for a long period of time, or during an electrical storm, as they may cause damage by lightning.
- 13 Do not attempt to modify or fix this unit. Contact the qualified YAMAHA service personnel when any service is needed. Cabinet should never be opened for any reasons.
- 14 Be sure to read 'TROUBLESHOOTING' section regarding common operating errors before concluding that this unit is faulty.

## ■ For U.K. customers

If the socket outlets in the home are not suitable for the plug supplied with this appliance, it should be cut off and an appropriate 3 pin plug fitted. For details, refer to the instructions described below.

### Note

- The plug severed from the mains lead must be destroyed, as a plug with bared flexible cord is hazardous if engaged in a live socket outlet.

## ■ Special Instructions for U.K. Model

### IMPORTANT

THE WIRES IN MAINS LEAD ARE COLOURED IN ACCORDANCE WITH THE FOLLOWING CODE:

Blue: NEUTRAL

Brown: LIVE

As the colours of the wires in the mains lead of this apparatus may not correspond with the coloured markings identifying the terminals in your plug, proceed as follows:

The wire which is coloured BLUE must be connected to the terminal which is marked with the letter N or coloured BLACK. The wire which is coloured BROWN must be connected to the terminal which is marked with the letter L or coloured RED.

Making sure that neither core is connected to the earth terminal of the three pin plug.

### FOR CANADIAN CUSTOMERS

To prevent electric shock, match wide blade of plug to wide slot and fully insert.

This Class B digital apparatus complies with Canadian ICES-003.

## FEATURES



### ● Home Theater Sound

This system delivers a realistic and powerful sound experience like that found in a movie theater just by connecting the VS-10 to the TV. You can also enjoy stronger bass and surround effects by adding the separately available YAMAHA NX-SW10, consisting of a subwoofer, a center speaker and two rear speakers.

### ● Includes Dolby Digital, Dolby Pro Logic and DTS Decoders

This system can reproduce the sound field of the software with the ,  or  logo mark.

### ● Virtual Surround (available for Virtual Dolby Digital)

The VS-10 can produce a virtual surround sound field when playing software with the ,  or  logo mark so that you can enjoy surround effects that give a motion to sound and make you feel like you are in action.

### ● Eight DSP programs including YAMAHA CINEMA DSP

Connecting the YAMAHA NX-SW10 (sold separately) allows eight different DSP programs to be used to enhance the power and realism of various sources, from movies to concerts, sporting events and games. Moreover, the SILENT CINEMA program allows you to enjoy Virtual Surround by connecting the headphones.

### ● Preset Remote Control

The remote control can be used to control not only the control center, but component from other manufacturers merely by setting the proper manufacturer code.



Manufactured under license from Dolby Laboratories. "Dolby", "Pro Logic" and the double-D symbol are trademarks of Dolby Laboratories. Confidential Unpublished Works. ©1992 – 1997 Dolby Laboratories, Inc. All rights reserved.



Manufactured under license from Digital Theater Systems, Inc. US Pat. No. 5,451,942 and other worldwide patents issued and pending. "DTS", "DTS Digital Surround", are trademarks of Digital Theater Systems, Inc. Copyright 1996 Digital Theater Systems, Inc. All Rights Reserved.

## CONTENTS

### PREPARATION

FEATURES .....	1	PREPARATION
GETTING STARTED .....	2	
NAMES OF ALL PARTS .....	4	
SPEAKER PLACEMENT .....	6	
INSTALLATION .....	7	
CONNECTIONS .....	9	
ADJUSTING THE SPEAKER OUTPUT LEVELS .....	15	

### OPERATION

OPERATING THE UNIT .....	17	OPERATION
USING CONVENIENT FUNCTIONS .....	19	
DSP PROGRAM (DIGITAL SOUND FIELD PROCESSOR EFFECT) .....	21	
MENU FUNCTIONS .....	24	

### REMOTE CONTROL

OPERATING OTHER COMPONENTS USING THE REMOTE CONTROL .....	27	REMOTE CONTROL
---	----	----------------

### APPENDIX

GLOSSARY .....	31	APPENDIX
TROUBLESHOOTING .....	32	
SPECIFICATIONS .....	33	
INDEX .....	34	

 indicates a tip for your operation.

# GETTING STARTED

## Checking the Package Contents

Check that the following accessories are included in the package.

### Remote control



### Batteries (AAA, R03, UM-4 type)

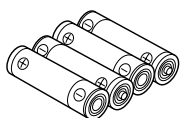

### Audio connection cord (2 pin, 1.5 m)

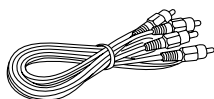

### Video connection cord (1.5 m)

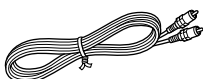

### Connection guide

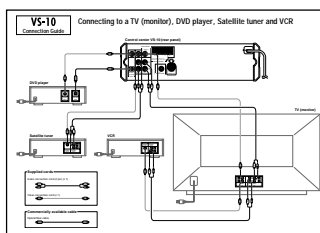

### Installation attachments for the control center

#### Supporting stand

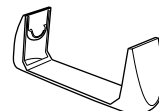

#### Side pads (x 2)



#### Bottom pads (x 4)



## Readying the Remote Control

### ■ Inserting the batteries

- 1 Remove the battery compartment cover.

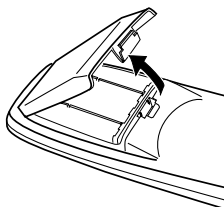

- 2 Insert the four batteries (AAA, R03, UM-4 type) with + and - oriented properly.

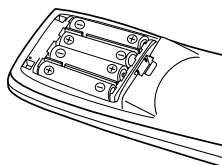

- 3 Close the battery compartment cover.

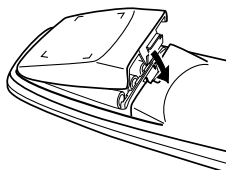

### ■ Precautions regarding batteries

Misuse of dry cell batteries may result in leakage or bursting. Be sure to follow the precautions given below.

- Insert batteries with (+) and (-) oriented according to the marking in the battery compartment.
- Do not mix old and new batteries.
- Do not mix different types of batteries as they may offer different voltage and performance even though they have the same shape.
- Remove all batteries when they can no longer be used or when the remote control will not be used for an extended period.
- Do not use rechargeable batteries.
- If leakage occurs, wipe away all battery fluid inside the compartment.

#### Preserving the manufacturer code

Replace batteries early before they become unusable. The manufacturer code set by the user will be preserved for about two minutes when batteries run out or when they are removed. Note that the manufacturer code setting may be lost if more than two minutes elapses.

## Operational Area of the Remote Control

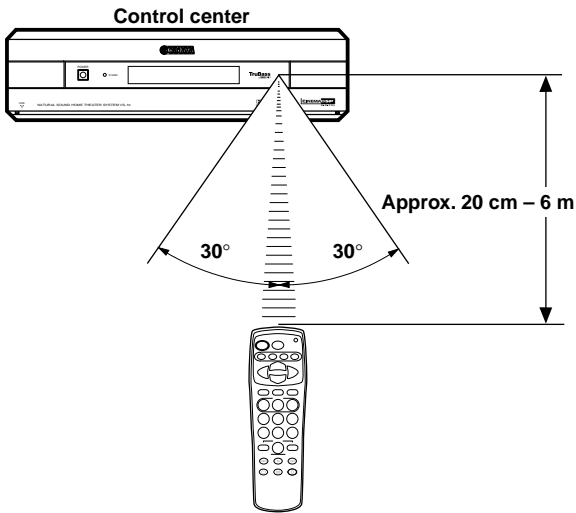

### ■ Battery replacement cycle

Replace all four batteries when the operational range of the remote control starts to become shorter.

### ■ Precautions on handling the remote control

- The remote control may not be able to operate the control center when an object blocks the remote control sensor on the unit.
- Do not subject the remote control to impact. Do not allow it to get wet or place it in a location subject to high humidity.
- The remote control operations become difficult when direct sunlight or other strong light (such as from an inverter fluorescent lamp) strikes the sensor. Adjust the relative positions of the light and the control center if this happens.
- Remote control operations may not be possible if another remote control is being operated at the same time.

# NAMES OF ALL PARTS

## Control Center (Front Panel)

### POWER (page 17)

Turns the power of the control center on and off. This button also turns off the subwoofer's power when the YAMAHA NX-SW10 (sold separately) is connected. The STANDBY indicator lights when power is turned off using  $\phi/1$  on the remote control.

### STANDBY indicator

When this indicator lights up, this unit consumes a very small quantity of power to receive infrared-signals from the remote control.

### DSP selector button (page 22)

### INPUT selector button (page 17)

### VOLUME $\nabla/\wedge$ (page 17)

### DIGITAL 2 optical digital input terminal

### DIGITAL 2 / VIDEO 2 video input terminal

### VIDEO 2 audio input terminals

### PHONES jack

Used to connect the headphones. No sound can be heard from the speakers when the headphones are connected.

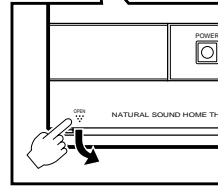

### To open the front door

Press downward "OPEN" on the left bottom of the front door. When the parts inside the front door are not used, put the front door back.

## Display

As the display becomes brighter for a few seconds each time this unit is operated, you can check the current operation clearly.

### Processing indicators (page 23)

### VIRTUAL indicator

### Phones indicator

Lights when the headphones are connected.

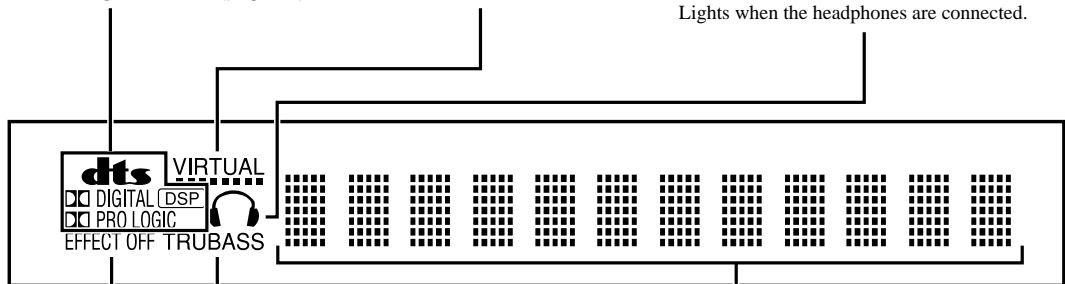

**EFFECT OFF indicator**  
Lights when the sound field effects is not turned on.

**TRUBASS indicator (page 19)**

**Shows the various information such as DSP program name, level or operational status**



# Remote Control

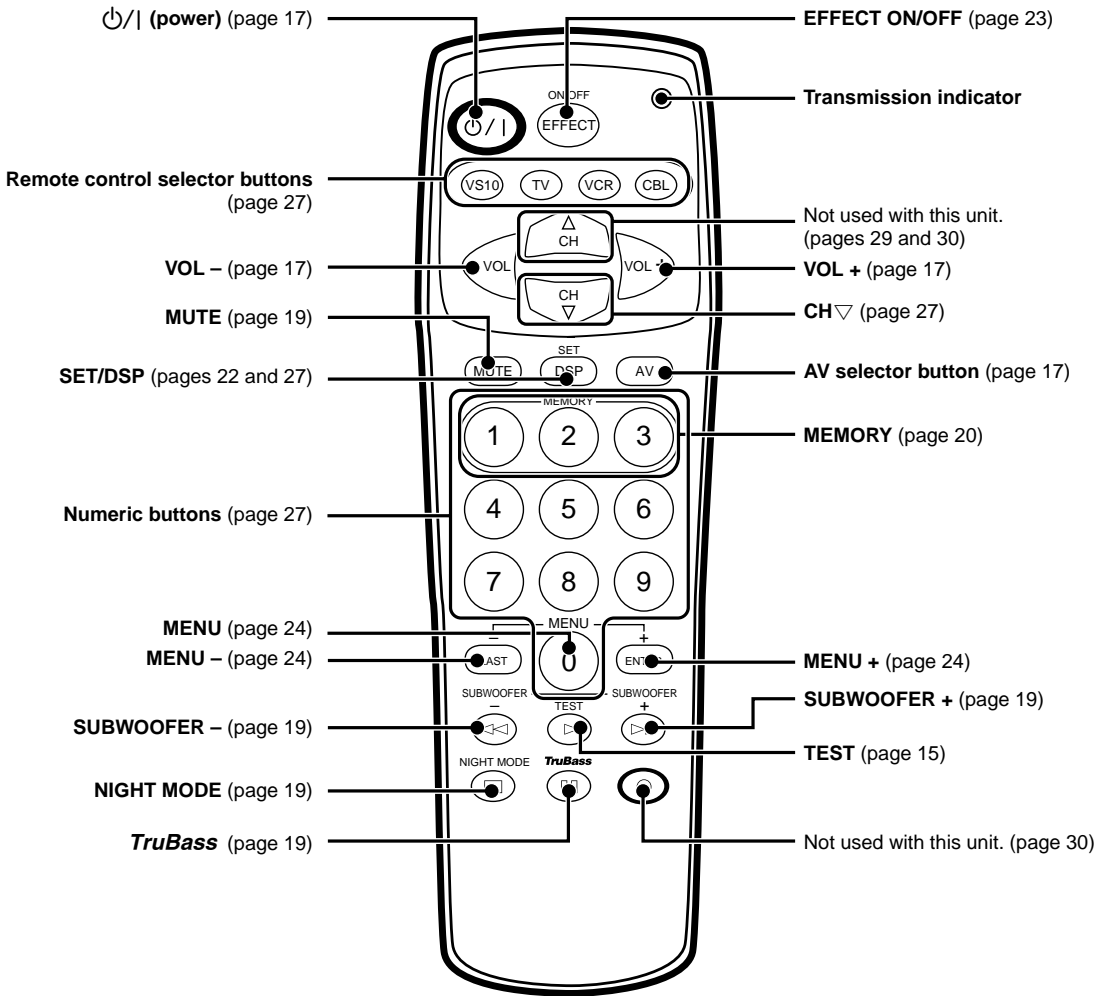

# SPEAKER PLACEMENT

Although speakers should ideally be placed as shown below, satisfactory effects may be obtained even if you do not strictly follow these guidelines.

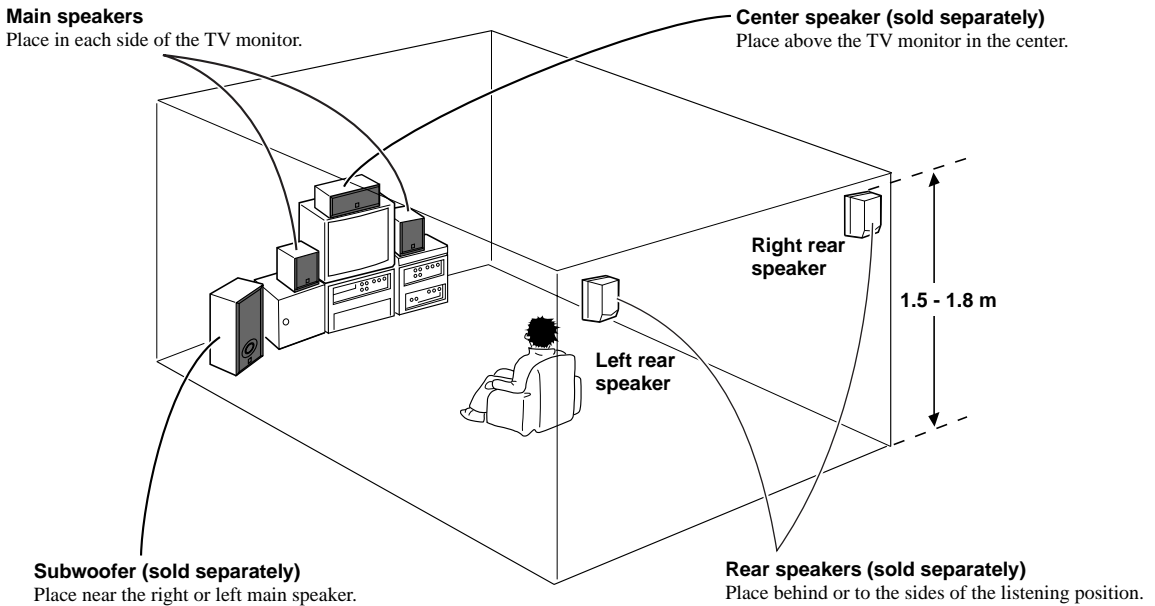

## ■ Main speakers NX-VS10M

Place the main speakers an equal distance from each side of the TV monitor.

Placing the main speakers at almost the same height as your listening position is more effective.

## ■ YAMAHA center speaker NX-VS10C (sold separately)

Place the center speaker on top of the television and align the front surface of the speaker with the front surface of the television monitor. If the speaker cannot be placed on top of the television, place it on a rack beneath the television as close to the television monitor as possible.

## ■ YAMAHA rear speakers NX-VS10E (sold separately)

Depending on room conditions, it is possible to place YAMAHA rear speakers NX-VS10E on shelves or hang them on the wall. Speakers should be placed about 1.5 m above the floor when you sit on the floor, or about 1.8 m above the floor when you sit on the chair.

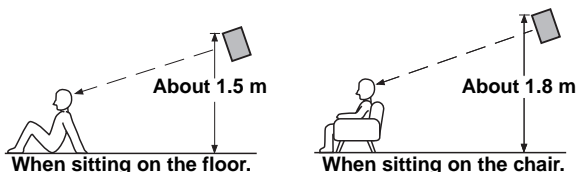

## ■ YAMAHA subwoofer SW-VS10 (sold separately)

Place the subwoofer at the outside of the either right or left main speaker and turn it slightly toward the center of the room to reduce the wall reflections. Try altering the position of the subwoofer versus the listening position as the relative position will affect the way the bass sounds.

### CAUTION

Although these main speakers are magnetically shielded, they may still affect the color on the television monitor when using the speakers near the television. Adjust the relative positions of the speakers and the television if this happens. Perform the following steps if you are using a magnetically shielded television.

- 1 Turn off the television.
- 2 Wait awhile and turn the television back on.

You can also use the screw holes on the bottom of the main speakers for installing the speakers on commercially available speaker stands.

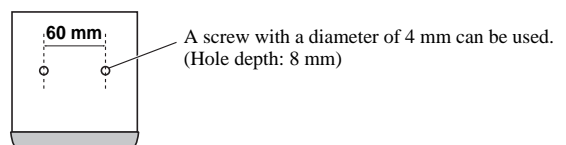

# INSTALLATION

Depending on room conditions, the control center can be installed vertically or horizontally.

## Precautions before installation

- Do not touch the adhesive surface after peeling off the pad as this will weaken its adhesive strength.
- Thoroughly wipe clean the surface where the pad is to be applied. Note that adhesive strength is weakened if the surface is dusty, oily or wet.

## *Installing the Control Center Horizontally*

Apply the four supplied bottom pads to the bottom of the control center.

**Peel off the seals of the bottom pads and apply to the four indented parts (screwed parts) on the bottom of the control center.**

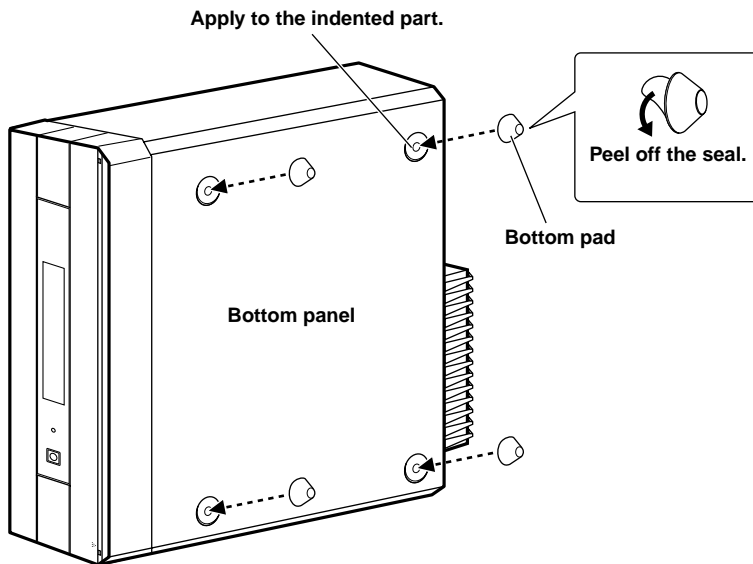

## CAUTIONS

- Be sure to use the bottom pads when installing the control center horizontally. Otherwise, the front door of the control center cannot open.
- Be sure to apply the bottom pads to the indented parts (screwed parts) on the bottom panel. Do not apply them to the indented parts on the top of the control center.

## *Installing the Control Center Vertically*

Apply the two supplied side pads to the side of the control center and attach to the supplied supporting stand.

- 1** Peel off the seals of the side pads and apply to the two indented parts (near to the front panel) on the left side of the control center.

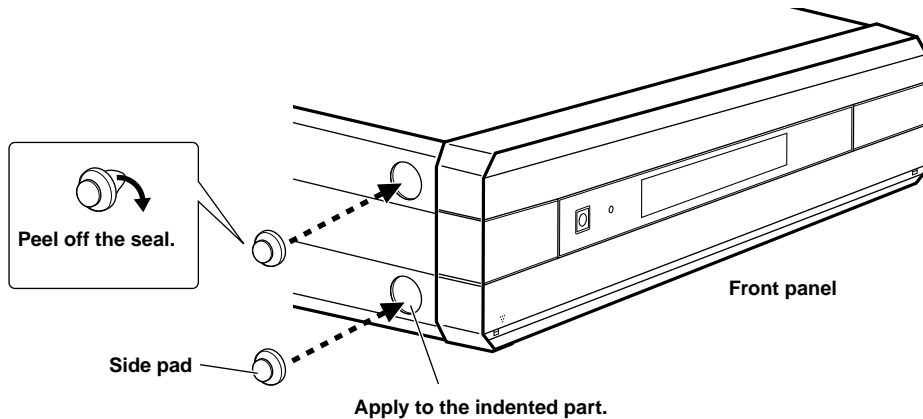

- 2** Attach the control center with the pads applied side facing down to the supporting stand as shown in the illustration below.

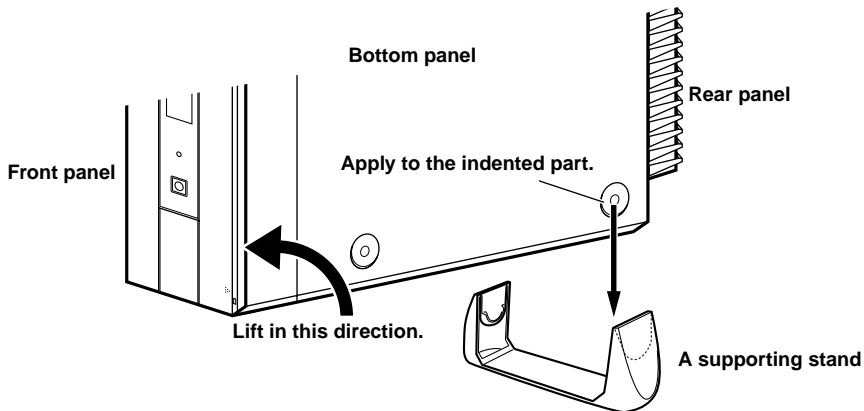

**Note**

- Using only the supporting stand makes the control center unstable and the front door cannot open. Be sure to use the side pads as well.

**CAUTIONS**

- Be sure to place the control center with the left side down.
- When installing the control center vertically on a high place such as on a shelf, do not place close to the edge.

# CONNECTIONS

## CAUTION

Always be sure to turn off the power of the control center and any component to be connected when making connections.

### To ensure proper connections

- Connect the white plug of the connection cord to the left “L” (white) audio signal terminal and connect the red plug to the right “R” (red) terminal.
- Insert the plug securely. If the plug is not inserted securely, noise may result or sound may not be output.
- Since the method of connection and terminal names differ depending on the component being used, be sure to refer to the instruction manuals for all components being connected.
- After connections have been made, check one more time that wiring has been made properly.

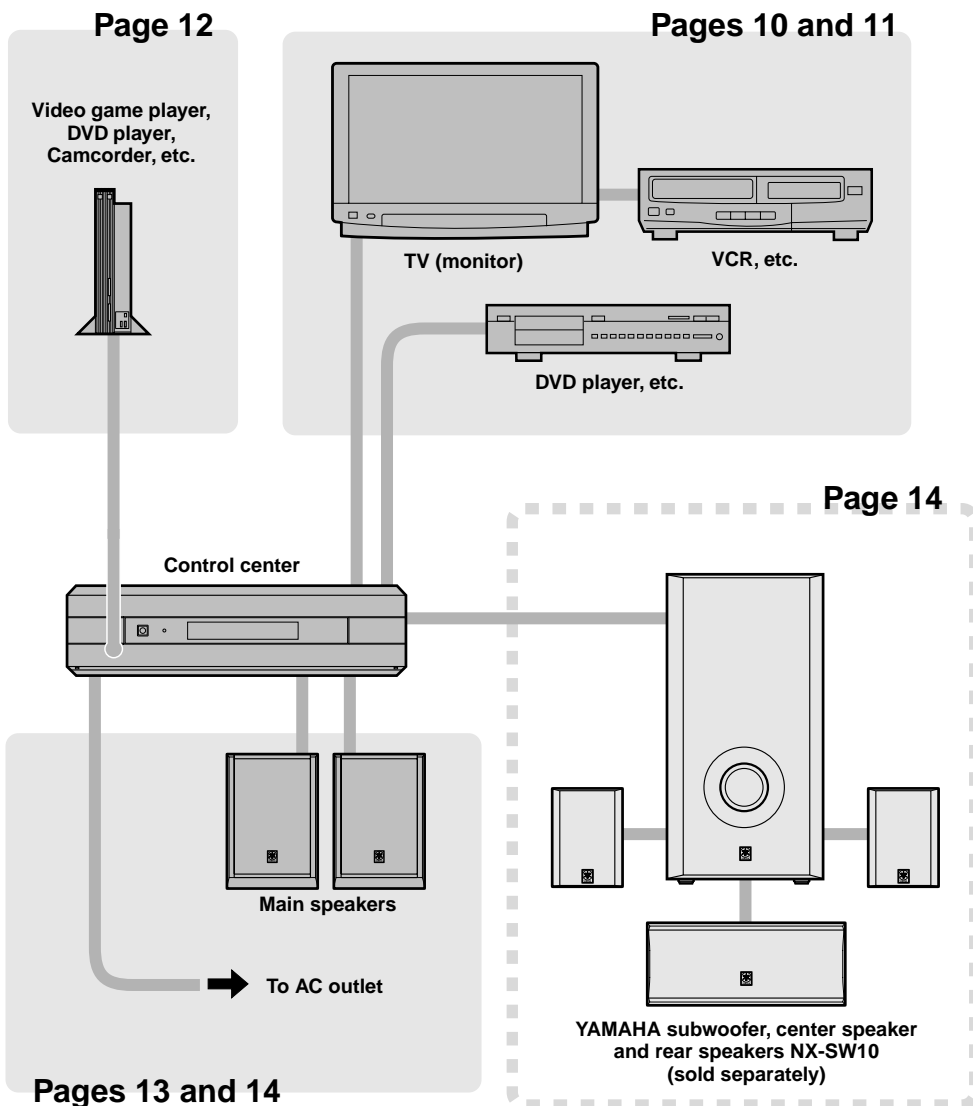

## Connecting a TV or VCR

### ■ Connecting a TV (monitor)

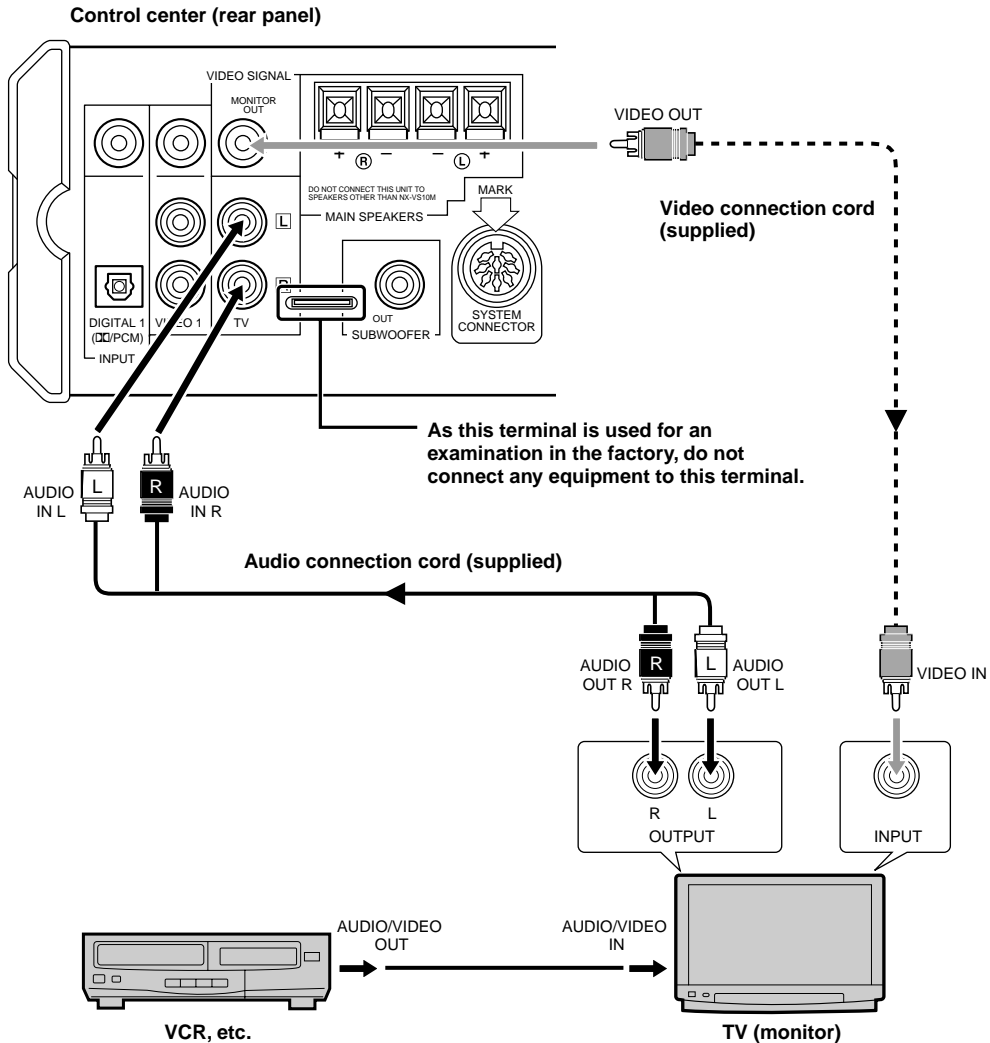

Connect the audio output terminals on the TV (monitor) to the TV audio input terminals on the control center using the supplied audio connection cord and the video input terminal on the TV (monitor) to the MONITOR OUT terminal on the control center using the supplied video connector cord.



- The sound from the TV can be heard using the speakers connected to the control center. (Although you can also hear the sound from the TV speakers, we recommend you to reduce the TV volume so that you may enjoy the full benefit of the VS-10.)
- To monitor the picture output from the component such as a DVD player, cable TV tuner, camcorder, video game player, etc. of which the video output terminal is connected to the video input terminal on the control center (as described on pages 11 and 12), switch the video input of the TV (monitor) connected to the MONITOR OUT terminal on the control center.
- The TV (monitor) without the audio output terminals cannot be connected to the control center.

## ■ Connecting a DVD player, cable TV tuner, etc.

PREPARATION

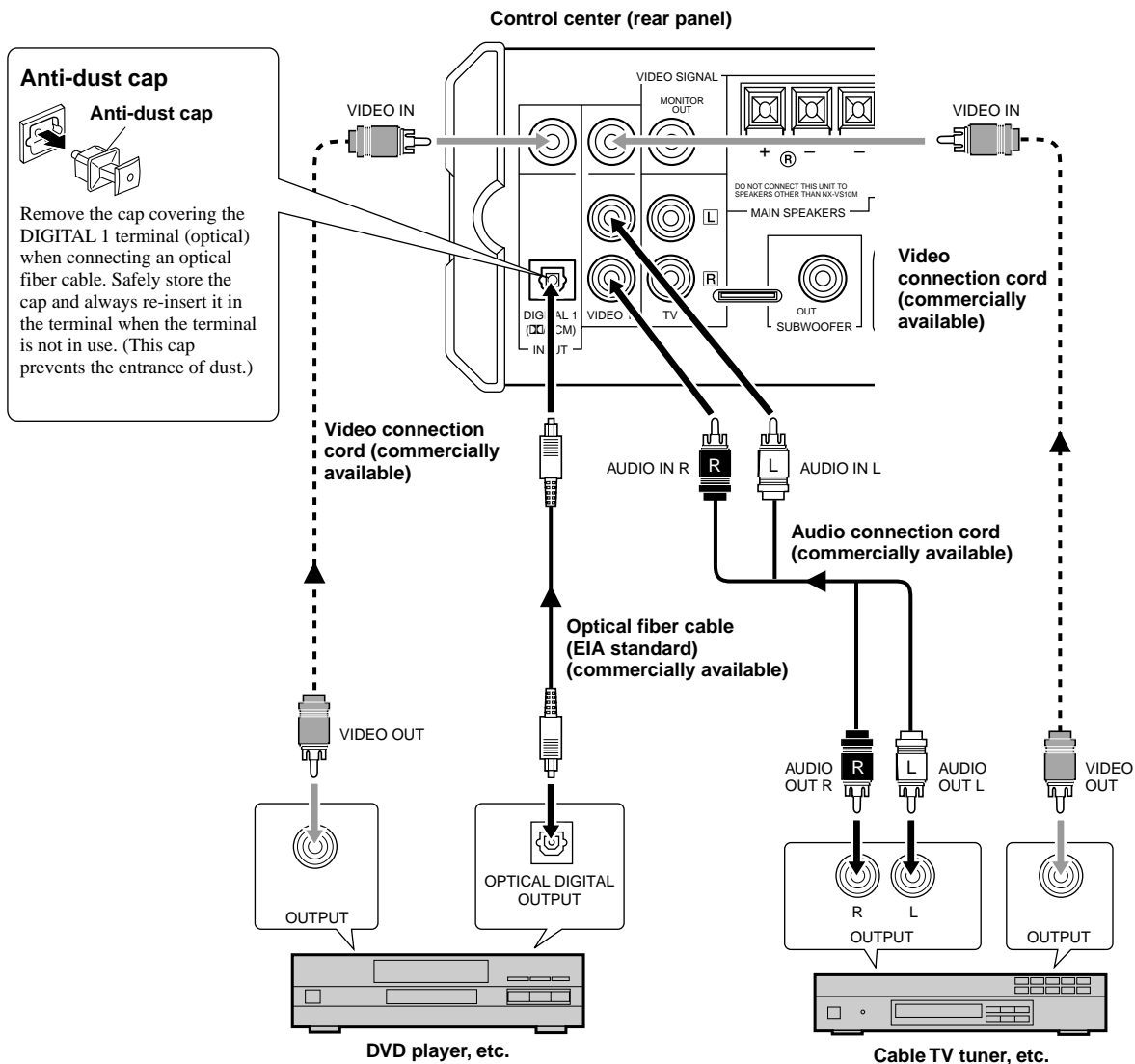

Connect the optical digital output terminal on the DVD player, etc. to the DIGITAL 1 (optical) digital input terminal on the control center using a commercially available optical fiber cable. This connection brings you digital sound.

When connecting the cable TV tuner, etc. without a digital output terminal, connect the audio output terminals to the VIDEO 1 audio input terminals on the control center using a commercially available audio connection cord (2 pin).

Also, connect the video output terminal on the DVD player to the DIGITAL 1 video input terminal on the control center using a commercially available video connection cord and the video output terminal on the cable TV tuner to the VIDEO 1 video input terminal on the control center using a commercially available video connection cord. However, when the DVD player, cable TV tuner, etc. has an S video output terminal, connect to the S video input terminal on the TV (monitor) directly so that you can obtain the high quality picture.



- The sound from a DVD player, cable TV tuner, etc. can be heard using the speakers connected to the control center. The sound cannot be heard from the TV's speakers. The sound from a DVD player, cable TV tuner, etc. cannot be heard when the power of the control center is turned off.
- **The VS-10 cannot record any audio or video source.**

English

## ■ Connecting a camcorder, video game player, etc.

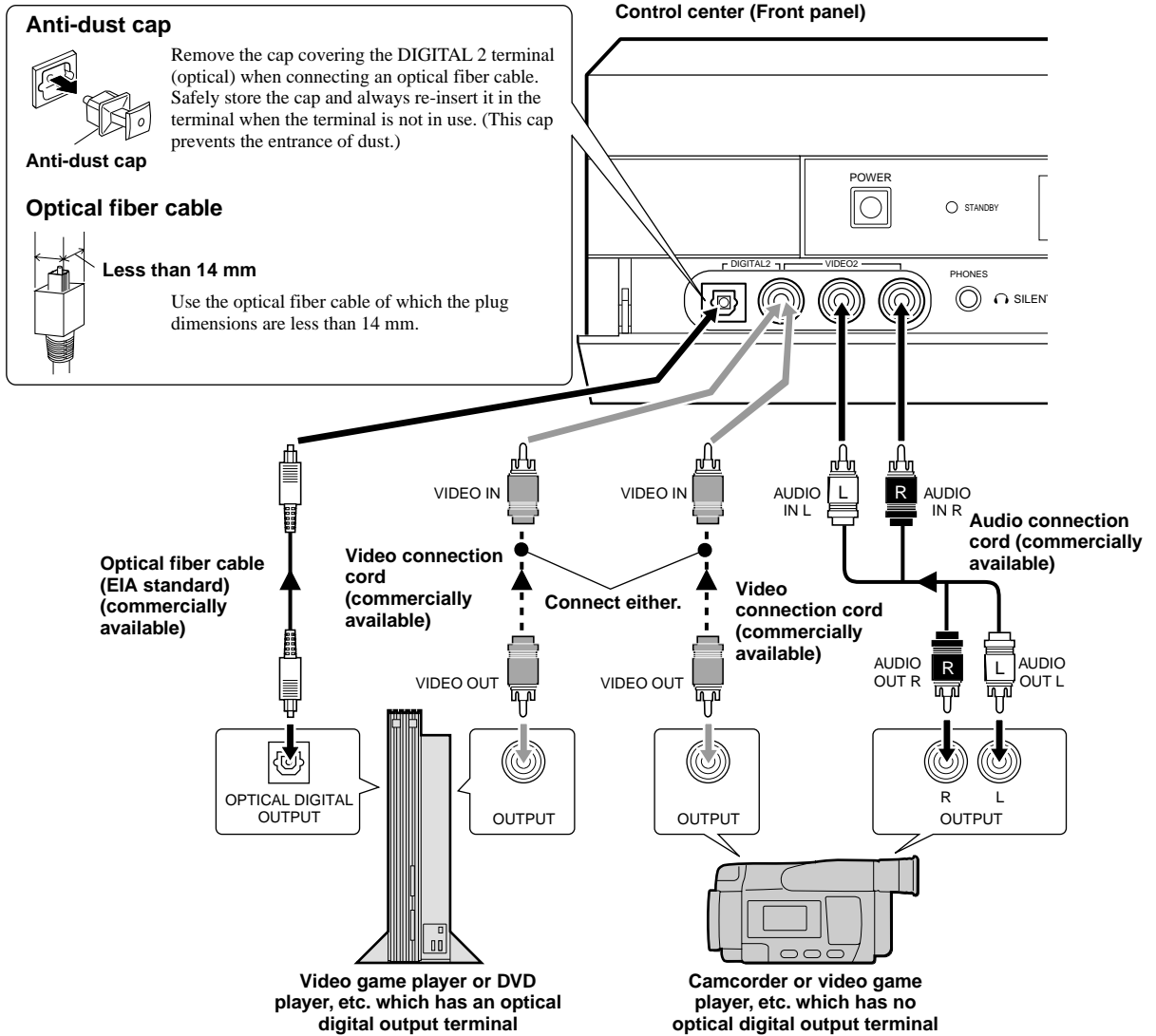

When connecting the video game player, DVD player, etc. with an optical digital output terminal, connect the optical digital output terminal to the DIGITAL 2 (optical) digital input terminal on the control center using a commercially available optical fiber cable. This allows you to enjoy a digital sound.

When connecting the camcorder, video game player, etc. without a digital output terminal, connect the audio output terminals to the VIDEO 2 audio input terminals on the front panel of the control center using a commercially available audio connection cord (2 pin).

Also, connect the video output terminal on the camcorder, video game player, etc. to the DIGITAL 2 (VIDEO 2) video input terminal on the control center using a commercially available video connection cord. However, when the camcorder, video game player, etc. has an S video output terminal, connect to the S video input terminal on the TV (monitor) directly so that you can obtain the high quality picture.



- The sound from camcorder, video game player, etc. can be heard using the speakers connected to the control center. The sound cannot be heard from the TV's speakers. The sound from a camcorder, video game, etc. cannot be heard when the power of the control center is turned off.
- **The VS-10 cannot record any audio or video source.**



## Connecting the Main Speakers

Connect the main speakers to the control center.

### Note

- Do not connect any speakers to the speaker terminals on the control center except for the supplied main speakers (NX-VS10M). Damage may result if a different speaker is connected.

Right main speaker (Rear panel)

Left main speaker (Rear panel)

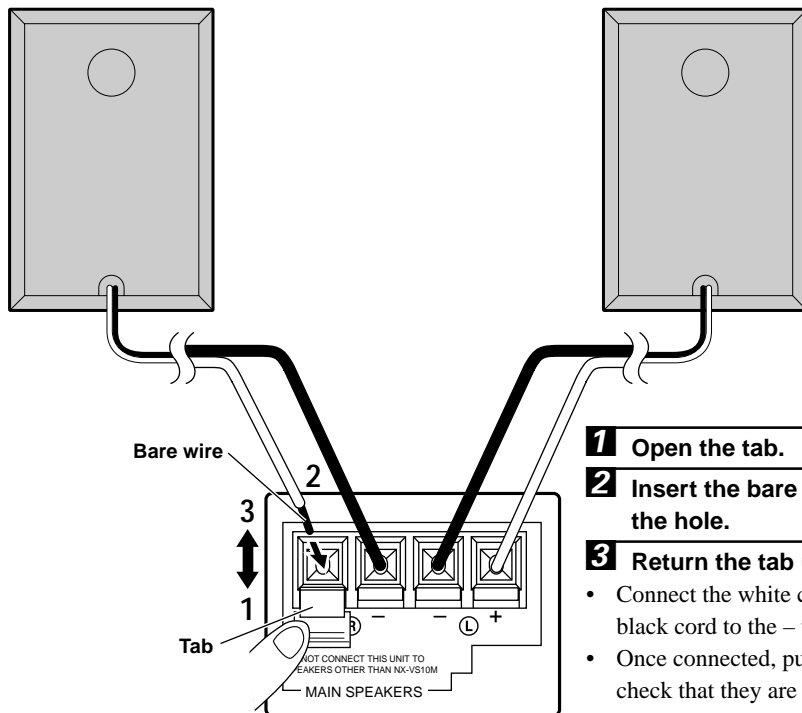

- Open the tab.
  - Insert the bare wire of the speaker cord into the hole.
  - Return the tab until it clicks.
- Connect the white cord to the + terminal (red), and the black cord to the – terminal (black).
  - Once connected, pull gently on the speaker cords to check that they are connected securely.

Control center (Rear panel)

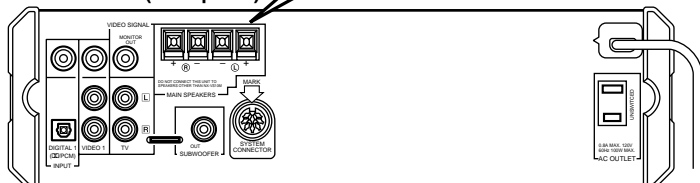

### CAUTIONS

- Do not let the bare speaker wire touch each other and do not let them touch any metal part of the speakers. This could damage the speakers.
- Do not mistakenly connect positive (+) to negative (–) or vice versa when connecting speaker cords.
- Insert the speaker cords securely so that positive (+) and negative (–) do not short. The speaker may not output any sound or may output noise, causing damage to the speakers, if speaker cords are not inserted securely.
- Only insert the bare wire portion of the speaker cords into the holes. Sound will not be output if you insert as far as the plastic insulation part of the cord.
- Secure the speaker cords so that they will not catch on hands or feet.

## Connecting the Control Center to the Subwoofer

Although the VS-10 alone can be used to reproduce rich and natural sounding audio, the additional use of a subwoofer allows you to enjoy powerful bass tones.

Connecting the YAMAHA subwoofer, center speaker and rear speakers NX-SW10 (sold separately) can not only increase bass sensitivity but improve the surround effect.

### Control center

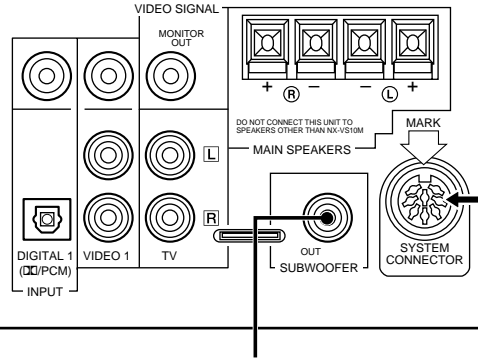

When connecting your subwoofer, connect the input terminal on the subwoofer to the SUBWOOFER OUT terminal on the control center using a commercially available audio connection cord (1 pin).

### YAMAHA subwoofer, center speaker and rear speakers NX-SW10 (sold separately)

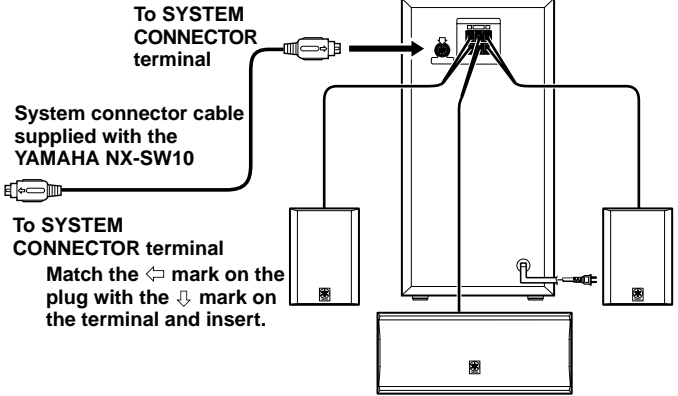

### Note

- When the power of the control center is turned off, that of the YAMAHA subwoofer SW-VS10 is also turned off accordingly.



- For details regarding connections, please refer to the instruction manuals for your subwoofer or the owner's manual for the YAMAHA subwoofer, center speaker and rear speakers NX-SW10 (sold separately).

## Connecting the AC Power Supply Cord

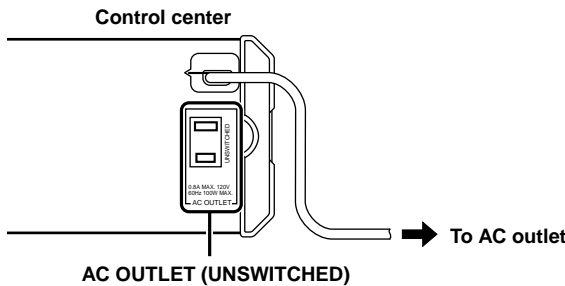

Once all connections have been made, check them one more time. Finally, insert the plug of the power supply cord for the control center into an AC outlet. Disconnect the power supply cord if you will not use the unit for an extended period.

### ■ AC OUTLET (UNSWITCHED) (Except for Australia model)

Use this outlet to connect the power cord of your component to this unit. This outlet will supply power to any connected component regardless of the operation of the POWER switch on the control center (or  $\text{ON/OFF}$  on the remote control). The maximum power that can be connected to the AC OUTLET is 100 W.

# ADJUSTING THE SPEAKER OUTPUT LEVELS

When reproducing the source encoded with a Dolby Digital, Dolby Surround or DTS, it is important to adjust the sound output level heard at the listening position to the same from each speaker. Therefore, the best performance of these digital sound fields can be obtained. Even when the other sound field is selected, you can enjoy the characteristics of each sound field.

Speaker output levels may be adjusted using the remote control before playback by following the steps.



## 1 Press $\text{P}/\text{I}$ to turn on the power.



If the STANDBY indicator is lit, turn on the power using  $\text{P}/\text{I}$  on the remote control. If the main power is off (when the STANDBY indicator is not lit), turn on the power by pressing POWER on the control center.

### CAUTION

When the NX-SW10 (sold separately) is connected to the control center, insert the plug of the AC power supply cord of the subwoofer SW-VS10 into an AC outlet beforehand and turn on the power of the control center.

## 2 Press TEST.

A test tone (like pink noise) will be output in the following order.

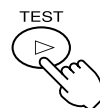

- When only the VS-10 is connected or the VIRTUAL SURROUND is selected:

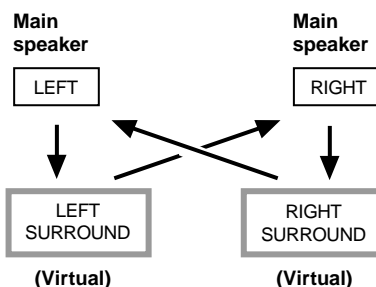

- When the NX-SW10 is connected:

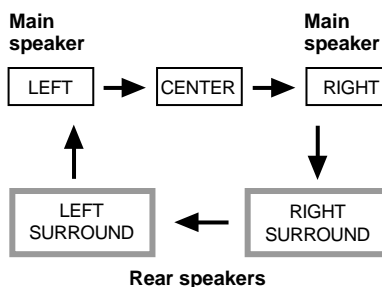

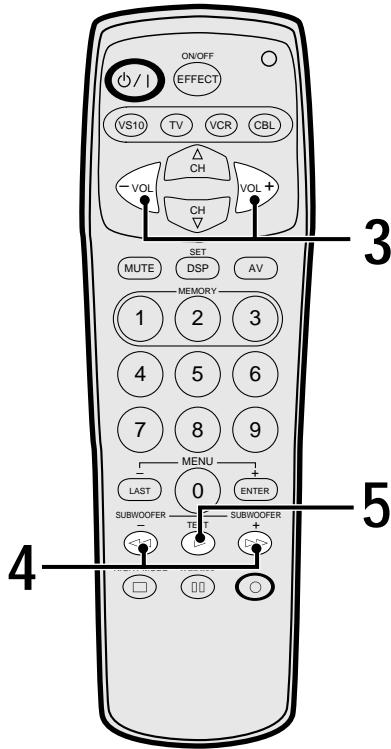

**3 Adjust the level of the test tone using VOL +/-.**  
(Adjust to your listening level.)

Pressing VOL + increases the level, while pressing VOL - decreases the level.

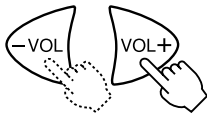

**4 Adjust the sound output level of each speaker while listening to the test tone.**

Pressing >> increases the level, while pressing << decreases the level.

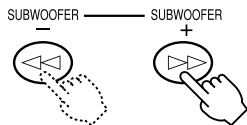

- When only the VS-10 is connected:  
Adjust the sound output levels of the rear virtual speakers and the main speakers so that they become almost the same.
- When the NX-SW10 is connected:  
Adjust the sound output levels of the center speaker and the rear speakers so that they become almost the same as that of the main speakers.

**Notes**

- When the sound output levels of the main speakers are adjusted, adjust the sound output levels of the center speaker, rear speakers and rear virtual speakers again.
- The sound output levels of right and left virtual speakers cannot be adjusted separately. While one level is adjusted, the other is also adjusted similarly.
- When the headphones are connected, the order of each speaker from which a test tone is heard is the same as that of VS-10 only. However, the sound output level of main speakers cannot be adjusted. Only the sound output level of rear speakers can be adjusted, however, that level cannot be adjusted for each right or left rear speaker separately. (Adjustable range: -3 to +3 dB)

**5 When the adjustment is complete, press TEST.**

A test tone stops.

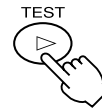

The sound output level can be adjusted in the following range.

- When only the VS-10 is connected or the VIRTUAL SURROUND is selected:
  - Right and left main speakers: -10 to ±0 dB
  - Rear virtual speakers: -3 to +3 dB
  - The minimum level for the main speakers is -10 dB, while that for the rear virtual speakers is -3 dB.
- When the NX-SW10 is connected:
  - Right and left main speakers: -10 to ±0 dB
  - Center speaker: -20 to +6 dB
  - Right and left rear speakers: -20 to +6 dB
  - The minimum level for the main speakers is -10 dB, while that for the center speaker and the rear speakers is -20 dB.

# OPERATING THE UNIT

## Enjoying the Home Theater Sound System

This section describes how to select the input source to enjoy the sound from a TV, VCR, DVD player, satellite tuner or video game player with the VS-10 and to adjust the volume.

First turn on the power of the playback component and the TV, and then follow the steps described below.

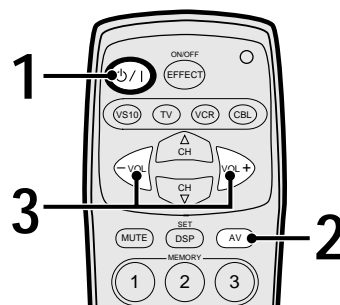
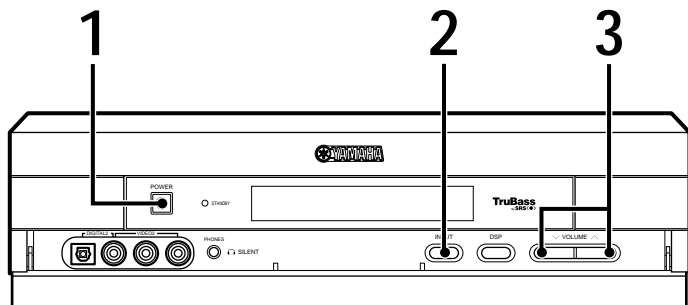

- 1** Press **POWER** on the control center and press  $\text{ON/OFF}$  on the remote control to turn on the power.

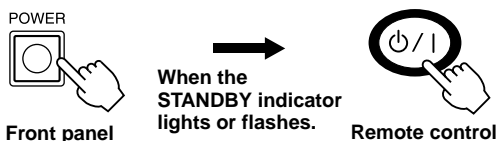

- When the STANDBY indicator lights or flashes, the power can be turned on using  $\text{ON/OFF}$  on the remote control. The power also can be turned on by pressing the INPUT selector button on the control center.
- The VS-10 memorizes the last state when the power is turned off. If you turn off the power using POWER on the control center in standby mode (when the STANDBY indicator lights), the unit enters standby mode when you press POWER on the control center next time.  
If you turn off the power using POWER on the control center when the power is turned on (when the STANDBY indicator does not light), the power is turned on when you press POWER on the control center next time.

- 2** Press the **INPUT** or **AV** selector button.

Each time the button is pressed, the input is switched in the order: VIDEO 1 → TV → VIDEO 2 → DIGITAL 1 → DIGITAL 2.

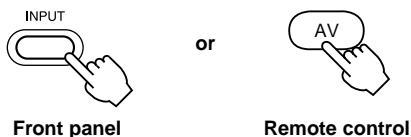

- 3** Adjust the level using **VOLUME**  $\wedge/\vee$  (or **VOL +/-** on the remote control).

Pressing **VOLUME**  $\wedge$  (or **VOL +** on the remote control) increases the level, while pressing **VOLUME**  $\vee$  (or **VOL -** on the remote control) decreases the level.

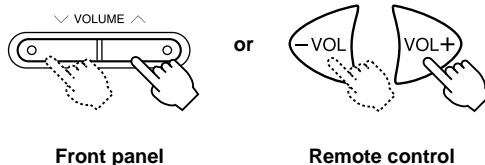

**CAUTION**  
When the “TV”, “VCR” or “CBL” button on the remote control is pressed to control another unit, the remote control can not control the VS-10. In this case, press the “VS10” button on the remote control and operate the VS-10.

## Switching the input mode

This function allows you to switch the input mode of the component connected to the DIGITAL 1 or DIGITAL 2 terminal to “Auto Mode” or “dts Fix”.

**Auto Mode :** This recognizes the PCM signal such as a CD, Dolby digital signal or DTS signal automatically.

**dts Fix :** This fixes to a DTS signal.

Normally, the playback can be performed with the “Auto Mode”. If you play a CD encoded with DTS in the “Auto Mode” setting, there will be a short noise at first while the unit recognizes the DTS signal and turns on the DTS decoder. This is not a malfunction and can be avoided by setting the input mode to “dts Fix” beforehand. When you play and stop a CD encoded with DTS in the “Auto Mode” setting, the sound is muted even if you play the PCM signal such as a normal CD and the **dts** indicator flashes for about 30 seconds. However, this condition is released after about 30 seconds.

### 1 Press the INPUT or AV selector button to select DIGITAL 1 or DIGITAL 2.

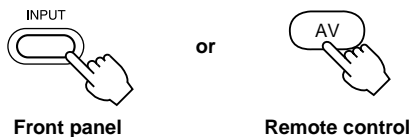

### 2 Press the INPUT or AV selector button again for about 3 seconds to switch the input mode.

Each time the button is pressed for about 3 seconds, the input mode is switched between “Auto Mode” and “dts Fix”, and displayed as follows.

“D1← dts Fix” ↔ “D1←Auto Mode”

- “D1” or “D2” is displayed before the selected input mode when DIGITAL 1 or DIGITAL 2 is selected respectively.

#### Notes

- The **dts** indicator lights when “dts Fix” is selected, and goes off when a digital signal encoded with DTS is not input in the “Auto Mode” setting.
- The setting of the input mode returns to “Auto mode” when the power of the control center is turned off.
- When playing a source encoded with DTS, be sure to connect the player to the DIGITAL 1 or DIGITAL 2 input terminal of the control center with an optical fiber cable.
- If the digital output data of the player has been processed in any way, you may not be able to perform DTS decoding even if you make a digital connection between this unit and the player.

#### CAUTION

The variable sound intensity range is large when playing back a CD or MD. So, if the source that includes the sudden change from a small sound level to large one is played back at a maximum volume for a long time, the speakers may be damaged.

# USING CONVENIENT FUNCTIONS

You can use convenient functions with the remote control during a playback.

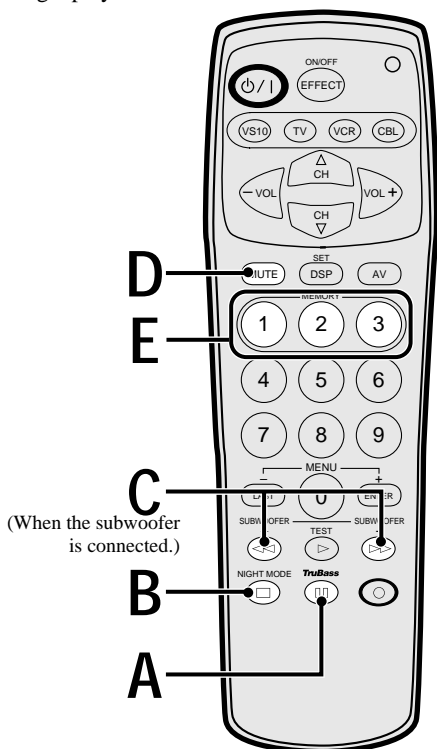

## A Enhancing the bass tones

Press **TruBass**.

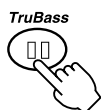

- The TRUBASS\* indicator lights in the display.
- This function enhances the bass tones by increasing the level of the low-range frequencies. When the SW-VS10 is connected, the bass tones of the subwoofer are also enhanced.

To cancel TRUBASS mode, press **TruBass** again.

### Notes

- The TRUBASS mode does not function when the headphones are connected.
- If a thudding noise is heard from the subwoofer when this function is turned on, lower the subwoofer level. Otherwise, the subwoofer may be damaged due to an excessive input level of low-bass signal.

\* **TruBass**™ and the **TruBass** symbol are trademarks of SRS Labs, Inc. in the United States and selected foreign countries. TruBass technology is incorporated under license from SRS Labs, Inc.

## B Listening to sound clearly at low levels

Press **NIGHT MODE**.



- Sounds become clear.
- Use this function when it is difficult to output high volumes such as late at night.

To cancel NIGHT MODE, press NIGHT MODE again.

### Notes

- The NIGHT MODE does not function when the headphones are connected.
- Volume cannot be decreased using this button. To decrease the volume, press VOLUME  $\nabla$  (or VOL - on the remote control).

## C Adjusting the subwoofer level

Subwoofer level can be adjusted when a subwoofer is connected.

Pressing **SUBWOOFER +** increases the level, while pressing **SUBWOOFER -** decreases the level.

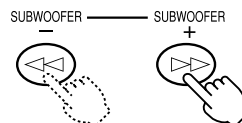

- The level can be adjusted within the range  $-20$  dB to  $+10$  dB.

### Note

- If a thudding noise is heard from the subwoofer when the TRUBASS function is turned on or when you play a bass-enhanced source such as 5.1 channel Dolby Digital or DTS which contains Low Frequency Effect, lower the subwoofer level. Otherwise, the subwoofer may be damaged due to an excessive input level of low-bass signal.

## D Muting the sound temporarily

Press **MUTE**.



- "Mute ON" is displayed when the sound is muted.

To return to the original volume level, press MUTE again. Pressing VOL+/- also cancels the muting mode and adjusts the volume level.

## E Calling Up Your Favorite Settings

Each MEMORY 1, 2 or 3 button can memorize the current input and the settings of DSP mode, SUBWOOFER level, TRUBASS and NIGHT MODE. Once the settings are preset, you can call up each MEMORY 1, 2 or 3 button anytime by simply pressing one of the MEMORY buttons.

---

### Memorizing the settings to each MEMORY 1, 2 or 3 button

Press and hold the MEMORY 1, 2 or 3 button to be memorized for about 3 seconds.

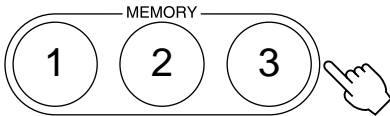

The number of button you pressed is displayed after “Memory” and the current settings are memorized.

Ex. : When the MEMORY 1 button is pressed, “Memory 1” is displayed.

---

### Calling up the favorite button’s memory

Press the MEMORY 1, 2 or 3 button to select the desired settings.

The number of button you pressed is displayed after “Memory” and the favorite settings are selected.

- If you keep pressing the button for more than 3 seconds, the previously memorized setting will be replaced with the current settings.

---

### Clearing the button’s memory

Press and hold the MEMORY 1, 2 or 3 button to be cleared for about 10 seconds. The number of the button you pressed is displayed after “MemoryClear” and the memorized settings are cleared. (When pressing the button, “Memory 1 (2 or 3)” is displayed after about 3 seconds, but keep pressing the button.)

- If you release the button before the display changes from “Memory” to “MemoryClear”, the button memorizes the current setting.



# DSP PROGRAM (DIGITAL SOUND FIELD PROCESSOR EFFECT)

You can recreate the sound and feel of a movie theater, concert hall or other location by selecting from any of eight DSP programs best suited to the source being reproduced. This allows you to enjoy the full experience of digital systems such as DOLBY DIGITAL, DOLBY PRO LOGIC, DTS, or YAMAHA CINEMA DSP (Digital Sound field Processor).

## Description of DSP Programs

### ■ When the VS-10 is connected without the YAMAHA NX-SW10:

No.	Program name	Features and applicable sources
1	<b>VIRTUAL SURROUND</b> (input source: Dolby Digital, Dolby Surround or DTS)	This program creates the virtual surround field that gives an experience as if you are enjoying with a Dolby Digital, Dolby Pro Logic or DTS only using the main speakers.
4	<b>GAME</b>	This program directs games to be more realistic and powerful adding a depth and surround feeling to the sounds.
5	<b>HALL</b>	This program reproduces the rich and full sound. This sound field brings a surround experience like that found in the center of the large amphitheater.
6	<b>CONCERT/SPORTS</b>	This program is suitable for many types of sound reproduction. Resonant sounds are retained so that it does not give the feeling unnatural even when this sound field is used for an extended period of time.
7	<b>MONO MOVIE</b>	This program is designed specially to enhance monaural source such as an old monaural movie.

### ■ When the VS-10 and the YAMAHA NX-SW10 are connected:

No.	Program name	Features and applicable sources
1	<b>VIRTUAL SURROUND</b> (input source: Dolby Digital, Dolby Surround or DTS)	This program creates the virtual surround field that gives an experience as if you are enjoying with a Dolby Digital, Dolby Pro Logic or DTS only using the main speakers.
2	<b>DOLBY DIGITAL</b> (input source: Dolby Digital) <b>DOLBY PRO LOGIC</b> (input source: Dolby Surround) <b>DTS</b> (input source: DTS)	This program straightforwardly reproduces the movie sound that is accurately processed using a Dolby Digital, Dolby Pro Logic or DTS decoder.
3	<b>DIGITAL MOVIE THEATER</b> (input source: Dolby Digital) <b>70mm MOVIE THEATER</b> (input source: Dolby Surround) <b>DTS MOVIE THEATER</b> (input source: DTS)	This program reproduces the rich and full sound found in a movie theater using the latest movie sound design in which dialog and sound effects are handled separately.
4	<b>GAME</b>	This program directs games to be more realistic and powerful adding a depth and surround feeling to the sounds.
5	<b>HALL</b>	This program reproduces the huge image of the amphitheater, which has all range reflected, rich and full sound, and strong surround feeling.
6	<b>CONCERT/SPORTS</b>	This program is suitable for many types of sound reproduction such as a variety show, live broadcast program, etc. Resonant sounds are retained so that it does not give the feeling unnatural even when this sound field is used for an extended period of time.

## DSP PROGRAM (DIGITAL SOUND FIELD PROCESSOR EFFECT)

No.	Program name	Features and applicable sources
7	MONO MOVIE	This program is designed specially to enhance monaural source such as an old monaural movie. Sound field effects and moderate resonance processing are used to bring fuller life to the monaural audio.

### Note

- When "GAME" or "HALL" is selected for a 2-channel source, no sound is heard from the center speaker even if the YAMAHA NX-SW10 is connected.

## ■ When the headphones are connected:

No.	Program name	Features and applicable sources
8	SILENT CINEMA	This program is for enjoying the three-dimensional virtual surround through the headphones. This sound field is suited for multi-channel movie software such as a DVD.

## Enjoying DSP Programs

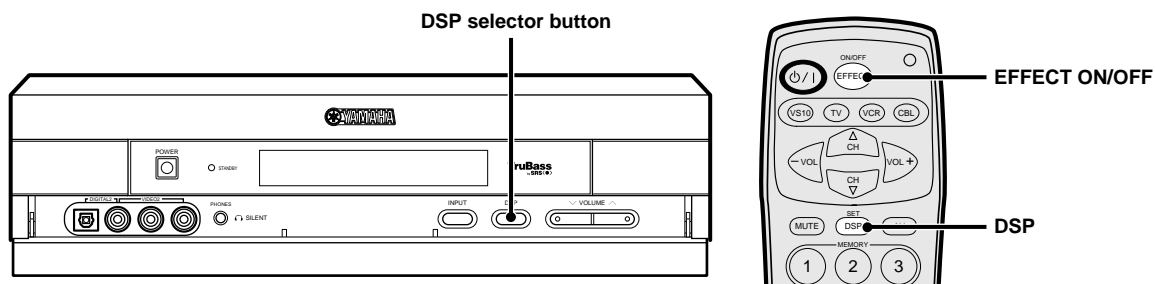

Press the DSP selector button (on the control center) or DSP (on the remote control).

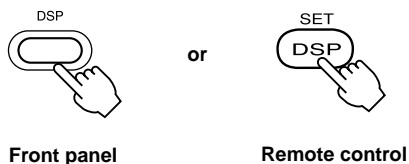

Each time this button is pressed, the DSP program is selected in the following order and the currently selected DSP program name is displayed.

- When the VS-10 is connected without the YAMAHA NX-SW10:

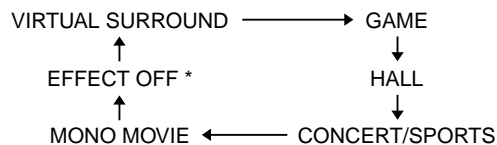

- When the VS-10 and the YAMAHA NX-SW10 are connected:

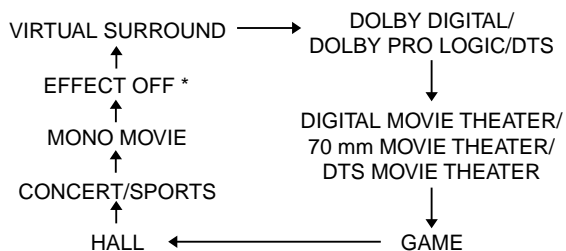

\* The "EFFECT OFF" appears only when using the DSP selector button on the control center.

- When the headphones are connected:

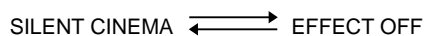

**Notes**

- Be sure to select the DSP program best suited for the atmosphere of the source being listened to.
- The last selected DSP program for each input source (VIDEO 1, TV, VIDEO 2, DIGITAL 1 and DIGITAL 2) is stored in memory. So, when the input source is changed, the DSP program is automatically changed to the last selected one correspondingly.



## ■ To cancel sound field effects (using the remote control)

### Press EFFECT ON/OFF.



The normal stereo playback is performed and “EFFECT OFF” is displayed when the sound field effect is canceled. Pressing this button again turns the sound field effect back on.

## ■ Processing indicators

A processing indicator displays the type of input signal when reproducing a source using a DSP program.

-  DIGITAL: Lights when reproducing a source encoded with Dolby Digital.
-  PRO LOGIC: Lights when reproducing a source encoded with Dolby Digital in 2-channel, PCM audio or an analog source using DSP program No. 2.
-  **dts**: Lights when reproducing a source encoded with DTS.
- DSP: Lights when reproducing a source using DSP program No. 3 through 7.

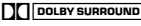
**Notes**

- The VIRTUAL SURROUND, DOLBY DIGITAL/DOLBY PRO LOGIC/DTS, DIGITAL MOVIE THEATER/70 mm MOVIE THEATER/DTS MOVIE THEATER are the optimum programs for reproducing visual software encoded with Dolby or DTS that displays the ,  or  logo marks.
- The volume level of the right and left main speakers may differ depending on the input source being used because, except in the case of Dolby Digital and DTS, sound field data as actually measured are used.
- Select the DSP program that you feel sounds best for a source regardless of its name. Besides, the sound field effect of the DSP program is affected by the resonance of the listening room. To enjoy the full performance of the DSP program, arrange the furnishings so that your listening room has less resonance.



- Be sure to minimize the volume level of the TV to maximize the virtual surround effect when reproducing a source with the VIRTUAL SURROUND program.
- Refer to the glossary on page 31.

# MENU FUNCTIONS

The menu functions include: “Auto Power” for setting automatic power on/off, “Dimmer” for adjusting display brightness, “Input Name” for naming inputs, “Center Delay” for adjusting the delay time used for the sound from the center speaker and “Delay Time” for adjusting the delay time used for the surround sound.

Adjustments on the menu functions should be performed with the remote control.

Each time MENU on the remote control is pressed, the function changes in the following order: “Auto Power”, “Dimmer”, “Input Name”, “Center Delay”, “Delay Time”, and input display.

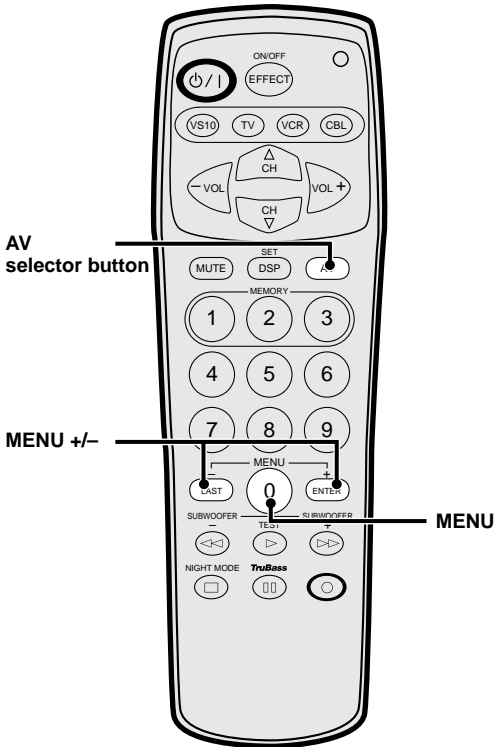

## Setting Auto Power On/Off

The Auto Power function works as described below.

No signal is input and no button is operated for about 30 minutes.

The unit enters the Auto Power Off mode. (The STANDBY indicator flashes slowly.)

The unit enters the Auto Power On mode and the power is turned on automatically when the signal is input\*. (or the power is turned on with  $\phi/1$  on the remote control or INPUT selector button on the control center.)

\* If the power is turned off and on using POWER on the control center and the signal is input in STANDBY mode, the power is turned on after about 5 seconds. (When a power failure is restored and the signal is input, the power is also turned on after about 5 seconds.)

You can set the sensitivity for the Auto Power function or turn the Auto Power function off.

**1** Press MENU to display “Auto Power”.



**2** To set Auto Power On, select the “Auto Power 2” using MENU +/- . To set Auto Power Off, select the “OFF” using MENU - .

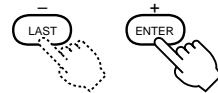

The Auto Power function may not work properly depending on the signal output level of the connected component. In this case, you can refer to the table described below to change the sensitivity of the Auto Power function.

Pressing + will change the display from top to bottom, while pressing - will change the display from bottom to top.

Display	Setting/Symptom
OFF	The Auto power function is turned off.
1	[Weak signal] Select this position when the unit does not enter the Auto Power On mode even when the signal is input, or the unit enters the Auto Power Off mode even when the signal is being input.
2	[Normal signal] Normally select this position to turn the Auto Power function on.
3	[Strong signal] Select this position when the unit enters the Auto Power On mode even when no signal is input, or the unit does not enter the Auto Power Off mode even when no signal is input.

After adjusting the menu functions, press MENU. The input display returns.

## Adjusting Display Brightness

The display brightness of the control center can be adjusted as follows.

### 1 Press MENU to display “Dimmer”.

The current brightness level (such as “Dimmer: ±0”) is displayed.

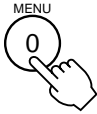

### 2 Press MENU + or – to adjust the brightness.

Pressing + brightens the display, while pressing – dims the display. Brightness can be adjusted from –3 (dimpest) to +3 (brightest). The brightness of +3 (brightest) is as same as that of the display right after the VS-10 is operated.

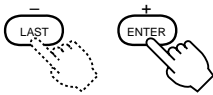

After adjusting the menu functions, press MENU. The input display returns.

## Naming the Input Terminals

It is possible to give names to the VIDEO 2, DIGITAL 1 and DIGITAL 2 input terminals. (It is not possible to change the input names for the TV or VIDEO 1 input terminals.)

Once you select a name so that you can easily find out which component is connected to the terminal, it is convenient when you select an input source. For example, if a video game player is connected to the VIDEO 2, you can name that source “GAME”, or if a DVD player is connected to the DIGITAL 1 terminal, you can name that source “DVD”.

### 1 Press MENU to display “Input Name”.



### 2 Press the AV selector button to select the input you want to name (VIDEO 2, DIGITAL 1 or DIGITAL 2).



### 3 Press MENU + or – to select the name.

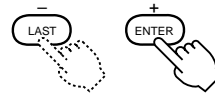

If you select VIDEO 2 in step 2 above, names are displayed in the following order when you press +.

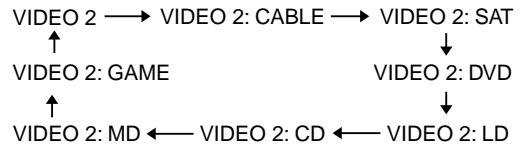

If you select DIGITAL 1 or 2 in step 2 above, names are displayed in the following order when you press +.

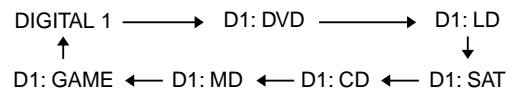

#### Notes

- “D1:” is displayed before the name when DIGITAL 1 is selected, while “D2:” is displayed before the name when DIGITAL 2 is selected.
- Pressing – displays the names in reverse order.

### 4 Repeat steps 1 through 3 to give names to VIDEO 2, DIGITAL 1 and DIGITAL 2 input terminals.

After adjusting the menu functions, press MENU. The input display returns.

## Adjusting the Center Delay Time

The center delay time is the time difference between the beginning of the sound from the main speakers and the beginning of the sound from the center speaker. When the other DSP program except for SILENT CINEMA is selected, it is possible to adjust the center delay time. This adjusts the delay between the main sound (on the main speakers) and dialog, etc. (on the center speaker).

This makes sounds from the left main, center and right main speakers reach your listening position at the same time. This is achieved by delaying the sound from the center speaker if the distance from the center speaker to your listening position is shorter than the distance from the right and left main speakers to your listening position. Each time the value of the center delay time is added by 1 ms, the center speaker is positioned farther from your listening position by about 30 cm virtually.

### 1 Press MENU to display "Cntr Delay".

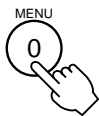

### 2 Press MENU + or - to adjust the center delay time.

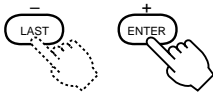

- Adjustable range  
0 to 5 ms

After adjusting the menu functions, press MENU. The input display returns.

## Adjusting the Delay Time

When the selected DSP program is VIRTUAL SURROUND, DOLBY DIGITAL/DOLBY PRO LOGIC/DTS or SILENT CINEMA, it is possible to adjust the delay time. The delay time is that time difference between when the sound from the main speakers can be heard and the surround sound can be heard.

The larger the value, the later the sound field effect is generated.

### 1 Press MENU to display "Delay Time".



### 2 Press MENU + or - to adjust the delay time.

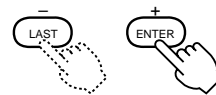

- Adjustable range
  - For Dolby Digital (except for 2 ch)/DTS input: 0 to 15 ms
  - For the other inputs: 15 to 30 ms

If the delay time level of a signal input is adjusted, that of other signal inputs will be changed. For example, when the delay time of the Dolby Digital (except for 2 ch)/DTS inputs is adjusted from 0 ms (minimum) to 5 ms, that of the other signal inputs is adjusted from 15 ms (minimum) to 20 ms automatically.

After adjusting the menu functions, press MENU. The input display returns.

# OPERATING OTHER COMPONENTS USING THE REMOTE CONTROL

Setting the manufacturer code for your TV, VCR or cable TV tuner/satellite tuner on the remote control allows you to operate not only the VS-10 but also your TV, VCR or cable TV tuner/satellite tuner using the remote control.

## Notes

- Remote control of some component may not be possible depending on the model and the year of make even though its manufacturer is listed on page i (at the end of this manual).
- Depending on the model, some components from other manufacturers cannot be controlled, or only limited functions can be controlled, even though the proper manufacturer code has been set. If you encounter this problem, please use the remote control supplied with the component.
- Setting the manufacture code can not be performed if your component to be controlled does not support remote control operation.

## Setting the Manufacturer Code

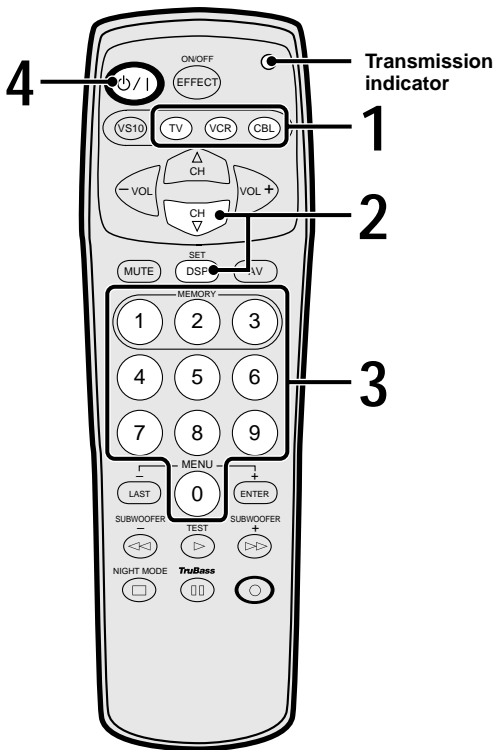

- 2** Hold down SET and press CH  $\nabla$  until the transmission indicator lights.

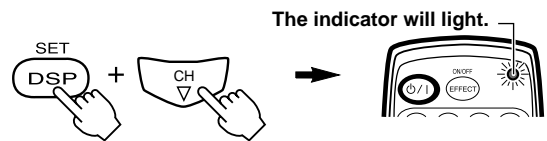

- 3** While the transmission indicator is lit, enter the 4-digit manufacturer code for the component to be controlled using the numeric buttons.

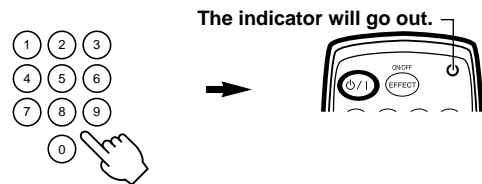

- 1** Press the remote control selector button (TV, VCR or CBL) for which the manufacturer code is to be set.

The signals for controlling the control center have already been set for the VS10 button so that only the manufacturer code for the TV, VCR or CBL needs to be set. A manufacturer code of the TV, VCR or cable TV tuner/satellite tuner can be set for the TV, VCR or CBL button respectively.



Enter the code surely. The transmission indicator goes out when the code is set properly. (The code has not been set properly if the indicator flashes and then goes out.)

Refer to the list of manufacturer codes on page i (at the end of this manual).

- 4** Press  $\text{ON/OFF}$  and check that the component to be controlled turns on and off.



## ■ Precautions when performing preset

The transmission indicator goes out once the manufacturer code is set properly.

If the transmission indicator does not go out, or if it flashes and then goes out, repeat the procedure from step 1.

Pay attention to the following points when you repeat the preset procedure.

- Check the manufacturer code number.
- Check that the correct remote control selector button has been selected when setting the manufacturer code.
- If more than one code is given for a manufacturer, try entering each code in the order given.
- Remove and replace the remote control's batteries (complete this step within 2 minutes) and then repeat the procedure.

## ■ When the remote control does not work correctly

When the remote control does not work correctly, try to enter the other manufacturer codes.

## ■ To clear a manufacturer code

Perform the procedure "Setting the Manufacturer Code" described on page 27 and enter the following codes when you reach step 3.

- To clear the "TV" button: 0000
- To clear the "VCR" button: 0000
- To clear the "CBL" button: 0000
- To clear all buttons: 9990



## Controlling a TV

You can control your TV by setting the corresponding manufacturer code for the remote control selector button “TV”.

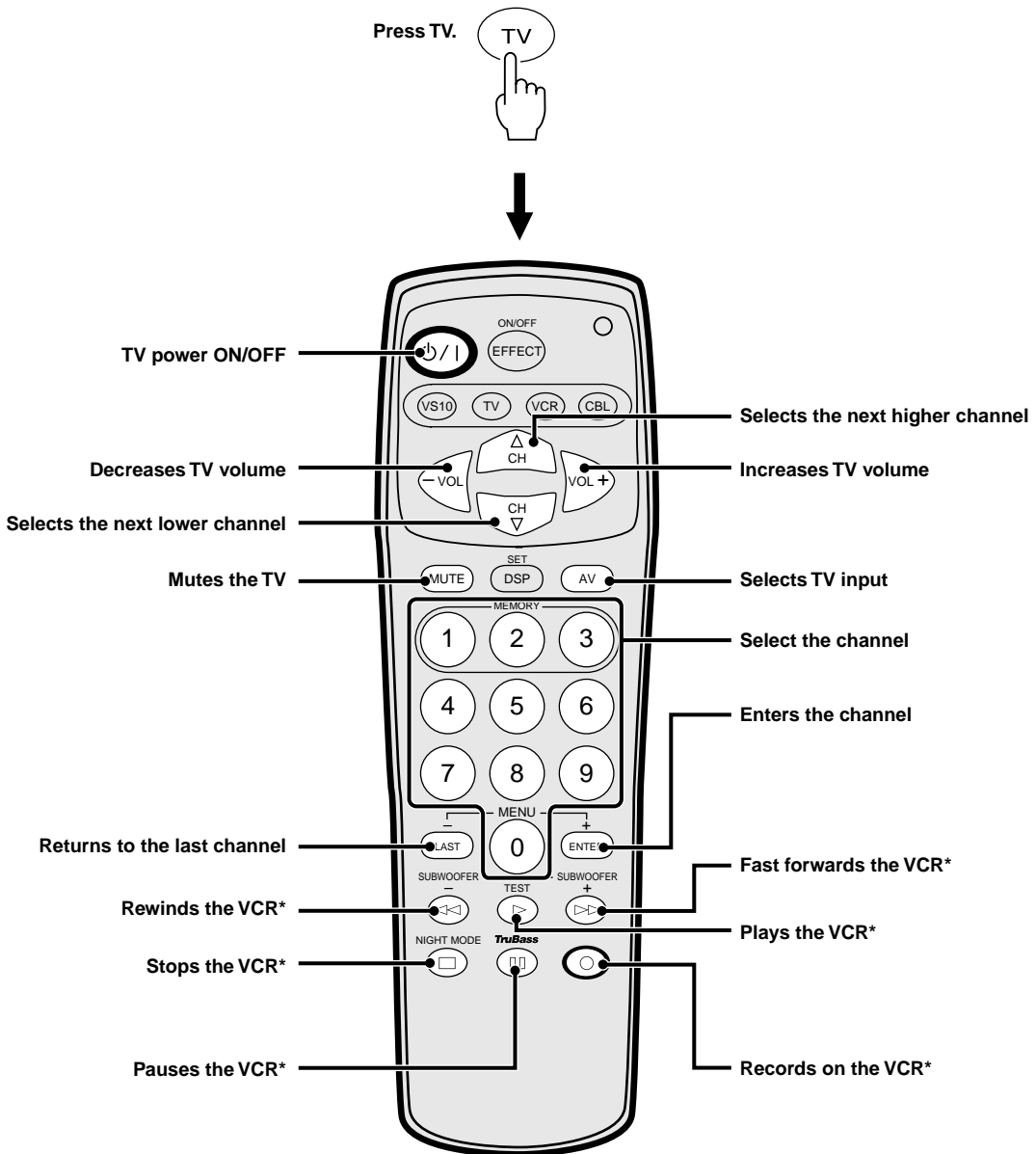

- A VCR can be controlled using \* marked buttons once the manufacturer code for that VCR has been set for the remote control selector button “VCR”.

## Controlling a VCR

You can control your VCR by setting the corresponding manufacturer code for the remote control selector button "VCR".

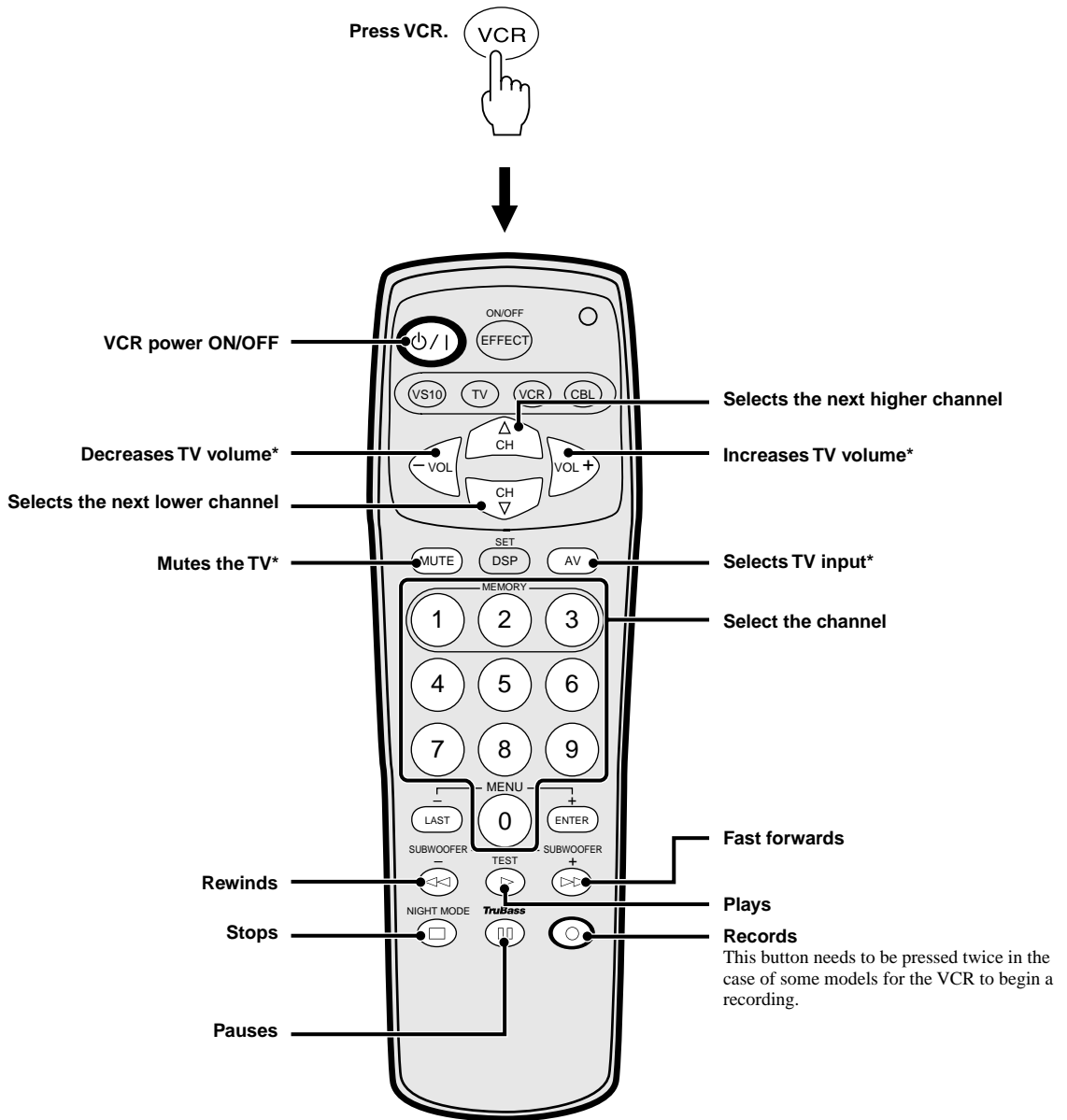

- A TV can be controlled using \* marked buttons once the manufacturer code for that TV has been set for the remote control select button "TV".

# GLOSSARY

## ■ Encode/Decode

When a signal or other information is processed, compressed and digitized, this is called encoding. Encoding can be used to record an extremely large amount of information on a single CD or DVD.

An encoded signal cannot be listened to directly. It must be returned to its original state (i.e. audible sound) and this is called decoding.

## ■ Sound field

Not all sound travels from the sound source directly into the human ear, but instead reflects off of walls, ceilings and other objects to arrive at the ear slightly delayed (early reflection). It may also reflect repeatedly in a complicated manner before reaching the ear (subsequent reverberation). A human is able to perceive the size and shape of a location based on the various sounds heard in this way. The specific acoustic space of a particular building is called a sound field.

## ■ Dolby Surround

In movie theaters and in live theaters, the spectators are surrounded by many speakers and sound effects geared to each scene are used to make sound move from front to back and right to left. This gives the sound a three dimensional feel that surrounds the entire body. Dolby Surround is used to implement this realistic effect. Originally, the Dolby Surround system consisted of a total of four channels: two front channels (right and left), one center channel, and one rear channel. Later, two-channel stereo compatibility was added to for broadcast and video media used in the home. The ability to easily set up a home AV system capable of stereo reproduction is one of the biggest features of Dolby Surround.

## ■ Dolby Digital

Dolby Digital consists of a total of five channels: three front channels (left, center and right) and two rear channels (right and left), plus a distinct LFE channel for low frequency effect. It is therefore commonly referred to as a 5.1 channel system. Using digital compression technology for all 5.1 channels, Dolby Digital can be used for completely independent audio reproduction. Dolby Digital offers superior sound separation between each channels and a more three dimensional surround effect in comparison to the older Dolby Surround, which mixes four channels (three front and one rear) into two-channel stereo and separates them using a matrix circuit.

## ■ DTS (Digital Theater Systems) Digital Surround

DTS was developed to replace the analog soundtracks of movies with six discrete channels of digital soundtracks, and it is now installed in many theaters around the world. The DTS digital playback system changed the way we experienced movies in theaters with six discrete channels of superb digital audio.

DTS technology, through intense research and development has made it possible to deliver similar encode/decode discrete technology to home audio surround-sound entertainment.

DTS Digital Surround is an encode/decode system which delivers six channels of master-quality, 20-bit audio; technically, it is 5.1 channels, which means 5 full-range (left, center, right and two surround) channels, plus a subwoofer (LFE) channel (as "0.1"). It is compatible with the 5.1 speaker configurations that are currently available for home theater systems.

## ■ Virtual surround

We basically perceive the direction from which sounds come to us based on the difference in time they reach the right and left ears and differences in sound level. Virtual technology is based on this property of the human ear. A DSP (digital sound field processor — a form of digital signal processing) and right and left main speakers are used so that the listener feels like he or she is hearing sounds that come from virtual speakers located in directions other than just the two physical speakers. This allows the listener to experience surround effects as if rear speakers were present as in a five-speaker system.

## ■ YAMAHA DSP (Digital Sound Field Processor)

YAMAHA technicians traveled to world famous concert halls, opera houses and other locations just to measure acoustical information such as the direction, intensity, band characteristics, and delay time of reflected sounds. This wealth of information was then put on a ROM.

Using a built-in YAMAHA DSP (digital sound field processor) to create sound fields, this unit allows you to freely select various sound field programs created from this actual acoustical data so that you can reproduce the sound field of concert halls and live houses right in your listening room.

Movie makers design sounds for a movie so that the sound and screen become one. Dialog is positioned right on the screen, sound effects behind the screen, music behind that, and surround effects wrap around the audience.

CINEMA DSP is a program for use in AV reproduction that has evolved from YAMAHA DSP. Fusing the movie sound decoders, Dolby Pro Logic, Dolby Digital and DTS, with YAMAHA DSP, allows you to reproduce the type of surround sound field of the quality found on a dubbing stage designed to optimize movie surround conditions. (A dubbing stage is the final mix used to complete the final sound design for a movie.)

By adding YAMAHA DSP processing to both the right and left front channels and the center channel, the CINEMA DSP program wraps the audience in a surround sound field that not only makes dialog real, but penetrates and surrounds the screen to give depth to sound effects and music as well as a smooth sense of movement to sound sources.

# TROUBLESHOOTING

Be sure to investigate thoroughly before requesting repairs or after service. If it cannot be corrected, or if the problem is not listed in the SYMPTOM column, disconnect the power cord and contact your authorized YAMAHA dealer or service center.

## Notes

- Sometimes the unit may cease to recognize operations due to a mistaken operation or as a result of strong external noise (such as irregular voltage due to shock of impact, excessive static electricity, or lightning strike). If this happens, first disconnect the power cord, wait about 30 seconds, re-connect the power cord, and try the desired operation again.
- When requesting repairs or after service of the YAMAHA subwoofer, center speaker and rear speakers NX-SW10 (sold separately), be sure to bring along with this unit.

## ■ General

SYMPTOM	CHECK	Refer to page
<b>No sound output at all.</b>	• Is the AC power supply cord connected?	14
	• Is the TV or VCR connected correctly?	10
	• Are the main speakers connected correctly?	13
	• Is the input source selected correctly?	17
	• Is the sound muted temporarily?	19
	• Are the headphones connected?	4
<b>A “humming” noise is present.</b>	• Hum caused by external electromagnetic waves may be generated. Try inverting the right-left polarity of the power cord and re-insert into the AC outlet.	14
<b>The STANDBY indicator flashes slowly.</b>	• The unit is in Auto Power Off mode. Turn off the main power if the unit is not to be used for an extended period of time.	24
<b>There is noise in the tuner or TV and the video image is unstable.</b>	• Is a tuner or TV that uses an indoor antenna located near the unit? Use of an outdoor antenna is recommended.	—

## ■ When using a DSP program

SYMPTOM	CHECK	Refer to page
<b>Movie dialog and other audio is difficult to hear.</b>	• Is HALL, CONCERT/SPORTS or GAME selected? Select the other DSP program.	21-22

## ■ When using the remote control

SYMPTOM	CHECK	Refer to page
<b>The remote control does not function properly.</b>	• Are the batteries used up?	3
	• Is the remote control pointed at the sensor?	3
	• Is the remote control too far from or too close to the sensor?	3
	• Is direct sunlight or other intense light (such as an inverter fluorescent lamp) striking the sensor?	3
	• Is another remote control being used at the same time?	3
	• Are the batteries inserted in the correct direction?	2
	• Is the remote control selector button “VS10” pressed? Press “VS10” when you want to control this unit after controlling another component.	—
<b>Cannot control other component.</b>	• Is the manufacturer code set correctly?	27
	• Is the remote control selector button corresponding to the component to be controlled pressed?	29-30

# SPECIFICATIONS

## Control Center

### ■ Amplifier Section

Minimum RMS Output Power  
Main ..... 25 W + 25 W (1 kHz, 10% THD, 6 ohms)  
Signal-to-Noise Ratio ..... 90 dB (VIDEO 1, IHF-A)

Total Harmonic Distortion  
..... 0.07% (Input: VIDEO 1, 1 kHz, 10 W/6 ohms)

Input Sensitivity/Impedance ..... VIDEO 1, 200 mV/50 k-ohms

### ■ Video Section

Video Signal Level ..... 1 Vp-p/75 ohms

## Main Speakers

Type ..... 2 way Bass-Reflex  
Speakers ..... 10-cm cone, magnetically shielded  
2 cm Super Tweeter

Maximum Input Power ..... 25 W  
Impedance ..... 6 ohms

## General

Power Supply  
[Europe and U.K. models] ..... AC 230 V, 50 Hz  
[U.S.A. and Canada models] ..... AC 120 V, 60 Hz  
[Australia model] ..... AC 240 V, 50 Hz

Power Consumption ..... 60 W  
Power Consumption (standby mode) ..... 5.5 W

Dimensions (W x H x D)  
Control center ..... 302 x 82 x 300 mm  
When installing vertically (including the supporting stand and side pads) ..... 124 x 302.5 x 300 mm  
When installing horizontally (including the bottom pads) ..... 302 x 88.5 x 300 mm  
Main speaker ..... 125 x 185 x 145 mm

Weight  
Control center ..... 4.7 kg  
Main speaker ..... 1.4 kg

Accessories ..... Remote control  
UM-4 batteries (x 4)  
Audio connection cord (2 pin, 1.5 m)  
Video connection cord (1.5 m)  
Supporting stand (x 1)  
Bottom pads (x 4)  
Side pads (x 2)  
Connection guide

Specifications are subject to change without notice.

# INDEX

<b>A</b>	
Adjusting display brightness .....	25
Adjusting the bass (subwoofer level) .....	19
Adjusting the center delay time .....	26
Adjusting the delay time .....	26
Adjusting the volume level .....	17
Auto Power on/off .....	24
<b>C</b>	
Center Delay → Adjusting the center delay time .....	26
CINEMA DSP → DSP program .....	21-23
Connecting a camcorder .....	12
Connecting a DVD player .....	11
Connecting a subwoofer .....	14
Connecting a TV .....	10
Connecting a VCR .....	10
Connecting the main speakers .....	13
Connecting the AC power supply cord .....	14
Connecting the YAMAHA NX-SW10 .....	14
Controlling a TV with the remote control .....	29
Controlling a VCR with the remote control .....	30
<b>D</b>	
Delay time → Adjusting the delay time .....	26
DIGITAL input terminal .....	11, 12
Dimmer → Adjusting display brightness .....	25
Display .....	4
DOLBY DIGITAL, DOLBY PRO LOGIC, DTS .....	21-23, 31
DSP programs .....	21-23
<b>M</b>	
Manufacturer codes .....	i (at the end of this manual)
Memory .....	20
Menu functions .....	24
Muting the audio .....	19
<b>N</b>	
Naming the input terminals .....	25
NIGHT MODE .....	19
<b>S</b>	
Selecting a sound field .....	22
Selecting the input .....	17
Selecting the input mode .....	18
Setting a manufacturer code .....	27
Speaker placement .....	6
<b>T</b>	
Test tone .....	15
TRUBASS mode .....	19
<b>V</b>	
VIRTUAL SURROUND .....	21-23

# LIST OF MANUFACTURER'S CODES

## LISTES DES CODES FABRICANT

### LISTA DE CÓDIGOS DE FABRICANTES

TV		DUMONT		JENSEN		OPTONICA	
A-MARK	1161	0891, 1031		0311		0541, 1141	
A TANDY	0941	DYNATECH	0881	JINXING	1531, 1541, 1551,	ORION	0831, 1001
ABEX	1151	ELECTROBAND	0951, 1011		1561, 1571, 1621,	OSAKI	0271, 1151
ADMIRA	1141	ELECTROHOME	0941		1631, 1641, 1651,	OTTO VERSAND	1001
ADVENTURA	1131	ELECTRON	0941		1691, 1731	PANASONIC	0101, 0191, 0251,
AIKO	1121	ELIN	1001	JVC	0261, 0281, 0641,		0751, 1041, 1311,
AIWA	1451	ELTA	0331		0651, 0661, 0841		1371, 1431
AKAI	0331, 1101, 1111	ENERSON	0001, 0021, 0061,	KAWASHO	0901	PANDA	1541, 1721
ALBA	0431		0071, 0081, 0091,	KAYPANI	1021	PENNY	0161, 0361, 0521,
ALLERON	1091		0111, 0811, 0821,	KENWOOD	0361, 1031, 1111		0531, 0621, 0731,
AMBASSADOR	1081		0831, 0841, 0851,	KLOSS	0631, 0721, 1131		0751, 0761, 0781,
AMSTRAD	0481, 1081		0861, 0871, 0901,	KTV	0921, 0941, 1011,		0791, 0861, 0931,
ANAM	0251, 1041, 1051,		0921, 0941, 0981,		1051, 1111		0941, 1031, 1041,
	1061, 1071		1011, 1031, 1051,	LEYCO	1001		1111, 1151, 1161
ANAM NATIONAL	1041		1081, 1091	LIESENK & TTER	1001	PEONY	1561, 1621
AOC	0361, 1021, 1031	ENVISION	0361, 1111	LLOYTRON	0941	PHILCO	0361, 0581, 0591,
	1111, 1161	ERRES	1001	LOEWE	1001		0601, 0611, 0631,
ARCHER	1161	ETRON	0331	LOGIK	0991, 1771		0961, 1031, 1111
AUDIOSONIC	1001	FERGUSON	1001	LUXMAN	0351, 0971	PHILIPS	0101, 0401, 1001
AUDIOVOX	1051, 1161	FINLUX	1001	LXI	0101, 0621, 0761,	PHONOLA	1001
BAUER	0441	FISHER	0171, 0801, 0981		0861, 0981	PILOT	0941, 1031, 1111
BAUR	1001	FORMENTI	0441	MAGNAVOX	0101, 0341, 0391,	PIONEER	0511, 0551, 0871
BEIJING	1511, 1551, 1561	FORMONTI	1001		0401, 0411, 0421,	PORTLAND	0941, 1031, 1121
BELCOR	1031	FORTRESS	1141		0581, 0591, 0601,	PRICECLUB	0931
BELL & HOWELL	0981, 0991	FUJITSU	1091		0611, 0631, 0661,	PRISM	0751
BEON	1001	FUNAI	1051, 1091, 1501,		0961, 1111	PROSCAN	0761
BRADFORD	1051		1521	MAJESTIC	0991	PROTECH	1001
BROCKWOOD	1031	FUTURETECH	1051	MARANTZ	0101, 0221, 0361,	PROTON	0501, 0861, 0941,
BROKSONIC	1161	GE	0131, 0161, 0201,		1001, 1111		1021, 1161
BUSH	1001		0751, 0761, 0771,	MARK	1001	PULSAR	0891
CANDLE	0351, 0361, 0961,	GEC	0271, 1001	MATSUI	0271, 0331, 1001	PULSER	1031
	0971, 1111, 1131	GEMINI	0391	MEDIATOR	1001	QUASAR	0251, 0751, 1041
CAPEHART	1021	GENEXXA	0431	MEGATRON	0691, 0861, 1161	QUELLE	1001
CARVER	0101	GIBRALTER	0891, 1031, 1111	MEI	1011	RADIO SHACK	0541, 0941, 1031,
CATHAY	1001	GOLDSTAR	0031, 0121, 0351	M-ELECTRONIC	1001		1051, 1151
CELEBRITY	0951		0411, 0731, 0741,	MEMOREX	0331, 0571, 0861,	RADIOLA	1001
CENTURION	0411		0861, 0941, 0971,		0971, 0981, 0991,	RCA	0051, 0141, 0151,
CHANGHONG	1541, 1551,		1001, 1031, 1111,	METZ	1771		0181, 0411, 0491,
	1561, 1621		1151		1791, 1831, 1891,		0531, 0761, 0771,
CITIZEN	0351, 0361, 0921,	GOODMANS/TASHIKO	0271, 0661, 1001		1901, 1911, 1921,	REALISTIC	0541, 0861, 0941,
	0931, 0941, 0961,			MGA	1931, 1941		0971, 0981, 1031,
	0971, 1111, 1121,	GRANADA	1001		0361, 0561, 0571,		1051, 1111, 1151
	1131	GRUNDIG	1781, 1791, 1801,	MIDLAND	0861, 1031, 1111	RHAPSODY	1011
CLAIRSTONE	1011		1811, 1821, 1831,		0751, 0761, 0891,	R-LINE	1001
CLARIVOX	1001		1841, 1851, 1861,	MITSUBISHI	0941, 1151	RUNCO	0891, 1111
CONCERTO	0351, 0971		1871, 1881		0221, 0321, 0561,	SAISHO	0331, 1081
CONROWA	1751	GUNPY	1051, 1091	MONTGOMERY	0571, 0661, 0861,	SAMPO	0361, 0941, 1021,
CONTEC	0901, 0911, 1011,	H/K	0721		1031, 1101, 1381		1111, 1151
	1051	HALLMARK	0861	MOTOROLA	1041, 1141	SAMSUNG	0331, 0341, 0351,
CORANDO	0941	HANSEATIC	1001	MTC	0351, 0361, 0931,		0361, 0861, 0931,
CRAIG	0251, 1051	HARVARD	1051, 1061		0971, 1011, 1031,		0941, 0971, 1001,
CROWN	0941, 1051	HINARI	1001, 1091		1111		1031, 1111, 1151
CURTIS MATHES	0161, 0361,	HITACHI	0181, 0351, 0671,	MULTITECH	0881, 1051	SAMSUX	0941
	0931, 0941,		0681, 0691, 0701,	NAD	0551, 0621, 0861	SANYO	0171, 0231, 0271,
	0981, 1111		0711, 0871, 0941,	NEC	0241, 0351, 0361,		0661, 0801, 0911,
CXC	1051		0971, 1351		0661, 0971, 1031,		0981, 1231, 1251,
DAEWOO	0291, 0301, 0331,	HYPSON	1001	NECKERMANN	1111, 1321, 1711		1261
	0721, 0941, 1001,	IMA	1051		1101, 1321, 1711	SBR	1001
	1031, 1121, 1191,	INDIANA	1001	NEI	1001	SCHIEDER	1001
	1531, 1581, 1591,	INFINITY REFERENCE	0101	NIKKAI	0271, 0431, 1001,	SCIMITSU	1031
	1601	INTERFUNK	1001		1151	SCOTCH	0861
DANSAI	1001	ITT	0611	NIKKO	0861, 1111, 1121	SCOTT	0831, 0861, 0941,
DAYTRON	0941, 1031	JANEIL	1131	NOVABEAM	0721		1031, 1051, 1091
DECCA	0271, 1001	JBL	0101	NTC	1121		
DIXI	0331, 1001, 1071	JCB	0951	ONWA	1051		
				OPTIMUS	0551		





COMTRONICS 0214, 0274  
 EAGLE COMTRONICS 0274  
 EASTERN 0064  
 ELECTRICORD 0204  
 ELECTUS 0264  
 GE 0114, 0124  
 GEC CABLE SYSTEM 0194  
 HAMLIN H5 0674  
 HAMLIN H6 0664  
 HAMLIN H6S 0654  
 HAMLIN H8 0644  
 HAMLIN H9 0634  
 JERROLD 0254  
 JERROLD 400L 0624  
 JERROLD 450L 0614  
 JERROLD 550 0604  
 JERROLD OSD CATV 0594  
 JERROLD SPRUCER 0434  
 MAGNAVOX/PHILIPS  
 0414, 0424  
 MAMM 0294  
 MEMOREX 0384  
 MOVIE TIME 0144, 0204  
 NORTHCOAST 0014  
 NSC 0144  
 OAK 0104  
 OAK SIGMA 450 0544  
 OAK SIGMA 550 0534  
 PANASONIC TZ 120/130 0474  
 PANASONIC TZ 170/180 0444  
 PANASONIC TZ140 0464  
 PANASONIC TZ150/160 0454  
 PARAGON 0384  
 PHILIPS 0034, 0214, 0304,  
 0314, 0324, 0334,  
 0344  
 PIONEER 0004, 0084  
 PIONEER BR50 0844  
 PIONEER BR60/70/80/81/82  
 0694  
 PIONEER BR90 0554  
 PULSAR 0384  
 RCA DIGITAL SATELLITE  
 SYSTEM 0394, 0404  
 REALISTIC 0134  
 REGENCY/EASTERN 0684  
 RUNCO 0384  
 SAMSUNG 0274  
 SCIENTIFIC ATLANTA 175/475  
 0574  
 SCIENTIFIC ATLANTA 75  
 0364, 0584  
 SCIENTIFIC ATLANTA 8650  
 0564  
 SIGNAL 0274  
 SL MARX 0274  
 SPECTAVISION 0234  
 STANDARD COMPONENTS  
 0184  
 STARCOM V 0254  
 STARGATE 0274  
 SYLVANIA/TEXSCAN  
 0374, 0494  
 TEKNIKA 0174  
 TELESERVICE 0054  
 TELEVIEW 0274  
 TEXSCAN 0184, 0374  
 TFC 0024  
 TOCOM 0224, 0354  
 TOCOM 5503A 0524  
 TOCOM 5503VIP/5507 0514  
 TOCOM TC56 0504  
 TOSHIBA 0384  
 TUDI 0044

UNIKA 0134  
 UNIVERSAL 0134, 0154, 0204,  
 0284  
 VIDEOWAY 0094  
 VIEWSTAR 0214  
 ZENITH 0244, 0384, 0484

---

### Satellite Tuner

ALPHA STAR 0824  
 CHAPARRAL 0754  
 ECHOSTAR 0834  
 GENERAL INSTRUMENT 0774,  
 0874  
 HTS 0834  
 HUGHES NETWORK SYSTEMS  
 0814  
 JERROLD 0774, 0784  
 PANASONIC 0804  
 PRIMESTAR 0774, 0784  
 RCA 0764  
 SONY 0794



A series of 28 horizontal lines for writing, spaced evenly down the page.



**YAMAHA ELECTRONICS CORPORATION, USA** 6660 ORANGETHORPE AVE., BUENA PARK, CALIF. 90620, U.S.A.  
**YAMAHA CANADA MUSIC LTD.** 135 MILNER AVE., SCARBOROUGH, ONTARIO M1S 3R1, CANADA  
**YAMAHA ELECTRONIK EUROPA G.m.b.H.** SIEMENSSTR. 22-34, 25462 RELINGEN BEI HAMBURG, F.R. OF GERMANY  
**YAMAHA ELECTRONIQUE FRANCE S.A.** RUE AMBROISE CROIZAT BP70 CROISSY-BEAUBOURG 77312 MARNE-LA-VALLEE CEDEX02, FRANCE  
**YAMAHA ELECTRONICS (UK) LTD.** YAMAHA HOUSE, 200 RICKMANSWORTH ROAD WATFORD, HERTS WD1 7JS, ENGLAND  
**YAMAHA SCANDINAVIA A.B.** J A WETTERGRENS GATA 1, BOX 30053, 400 43 VÄSTRA FRÖLUNDA, SWEDEN  
**YAMAHA MUSIC AUSTRALIA PTY, LTD.** 17-33 MARKET ST., SOUTH MELBOURNE, 3205 VIC., AUSTRALIA

**YAMAHA CORPORATION**  
Printed in Malaysia  V672800-1

# VS-10

## Connection Guide

# Connecting to a TV (monitor), DVD player, Satellite tuner and VCR

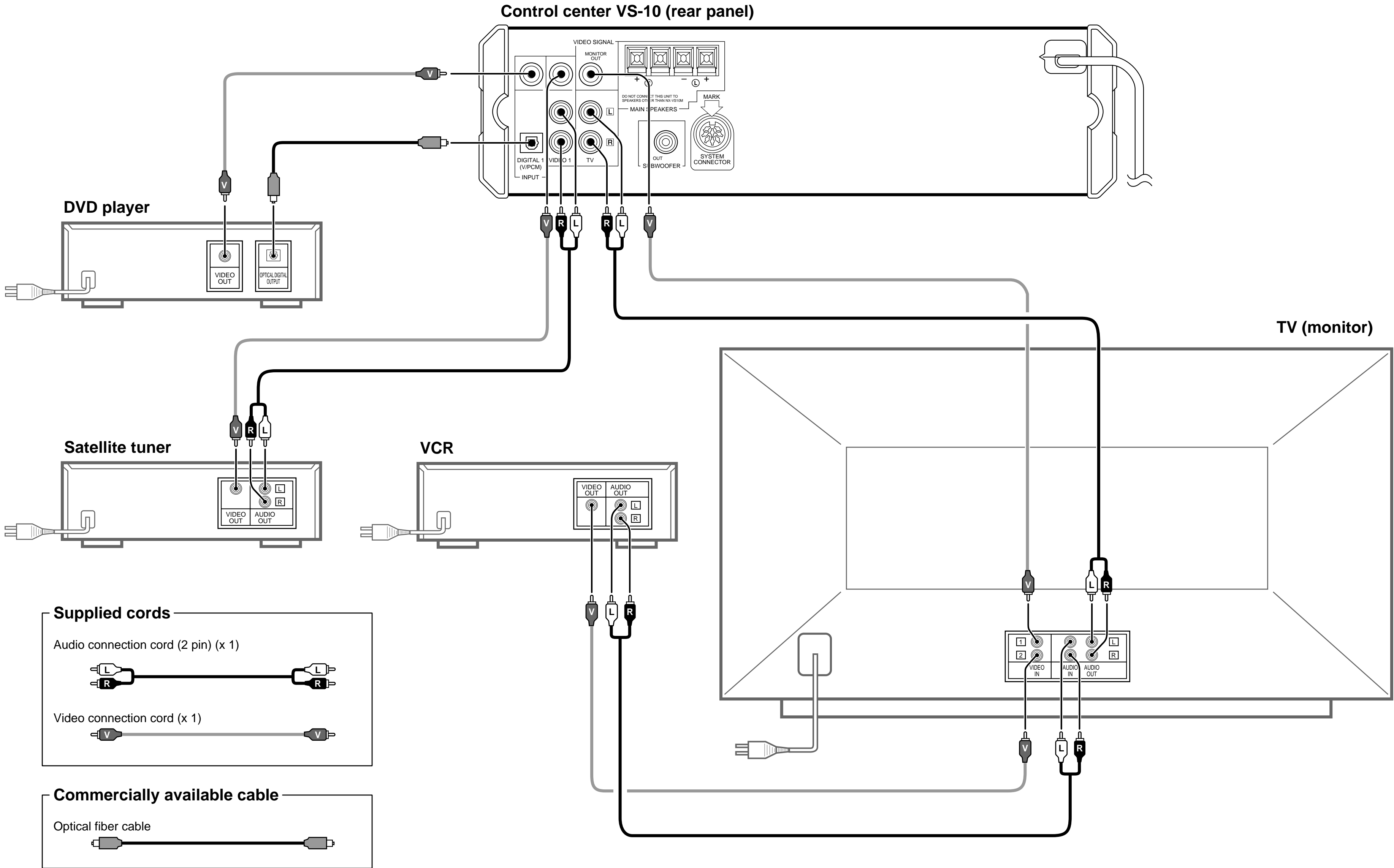

# VS-10 Connection Guide

## Connecting to a camcorder and video game player

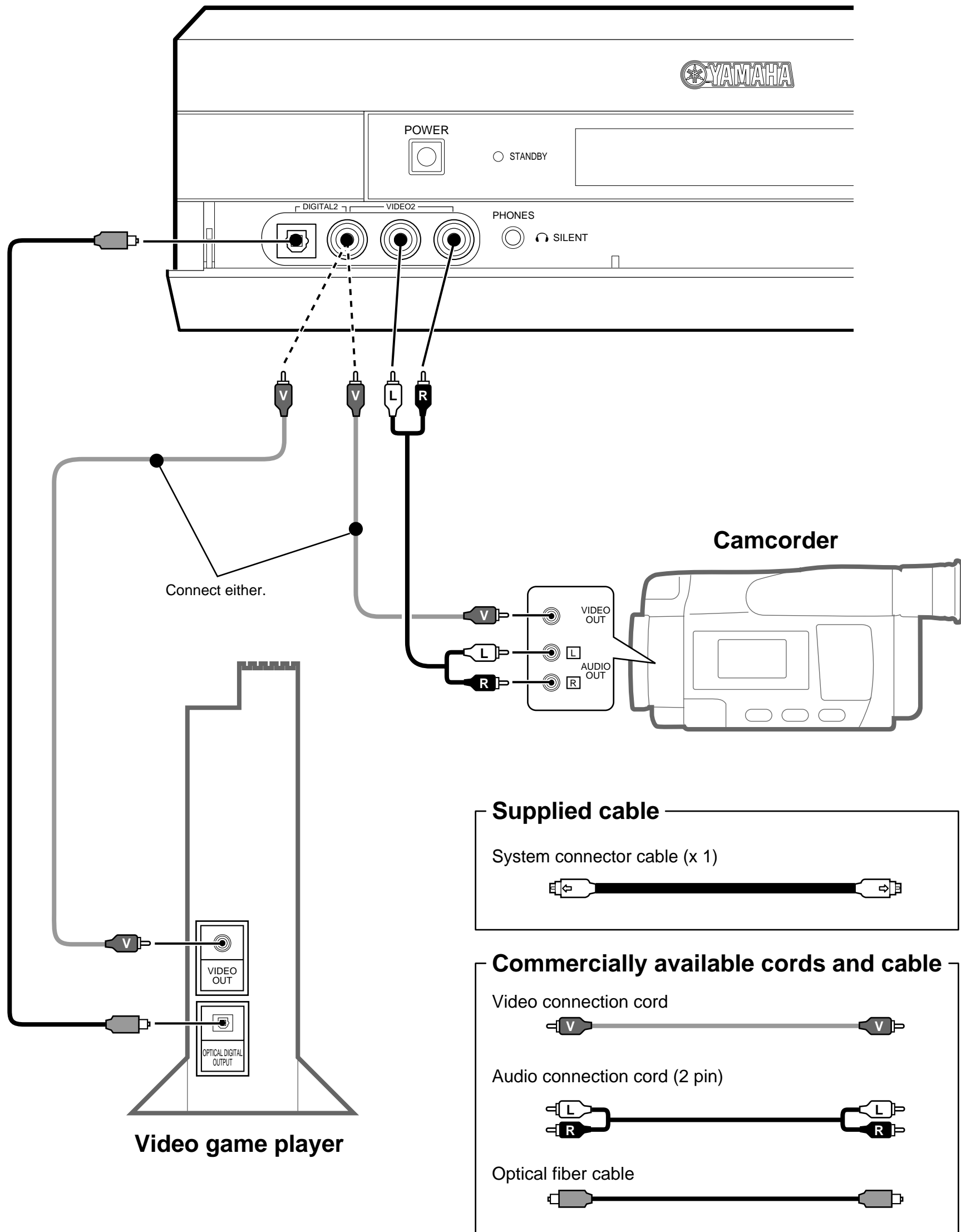

## Connecting the main speakers (supplied) and YAMAHA subwoofer/center speaker/rear speakers NX-SW10 (sold separately)

